

# ELEKTOR 22

up-to-date  
electronics for  
lab and leisure  
February 1977 45p

local radio  
ic power supply  
mind-bender  
hi-fi dynamic range  
compressor

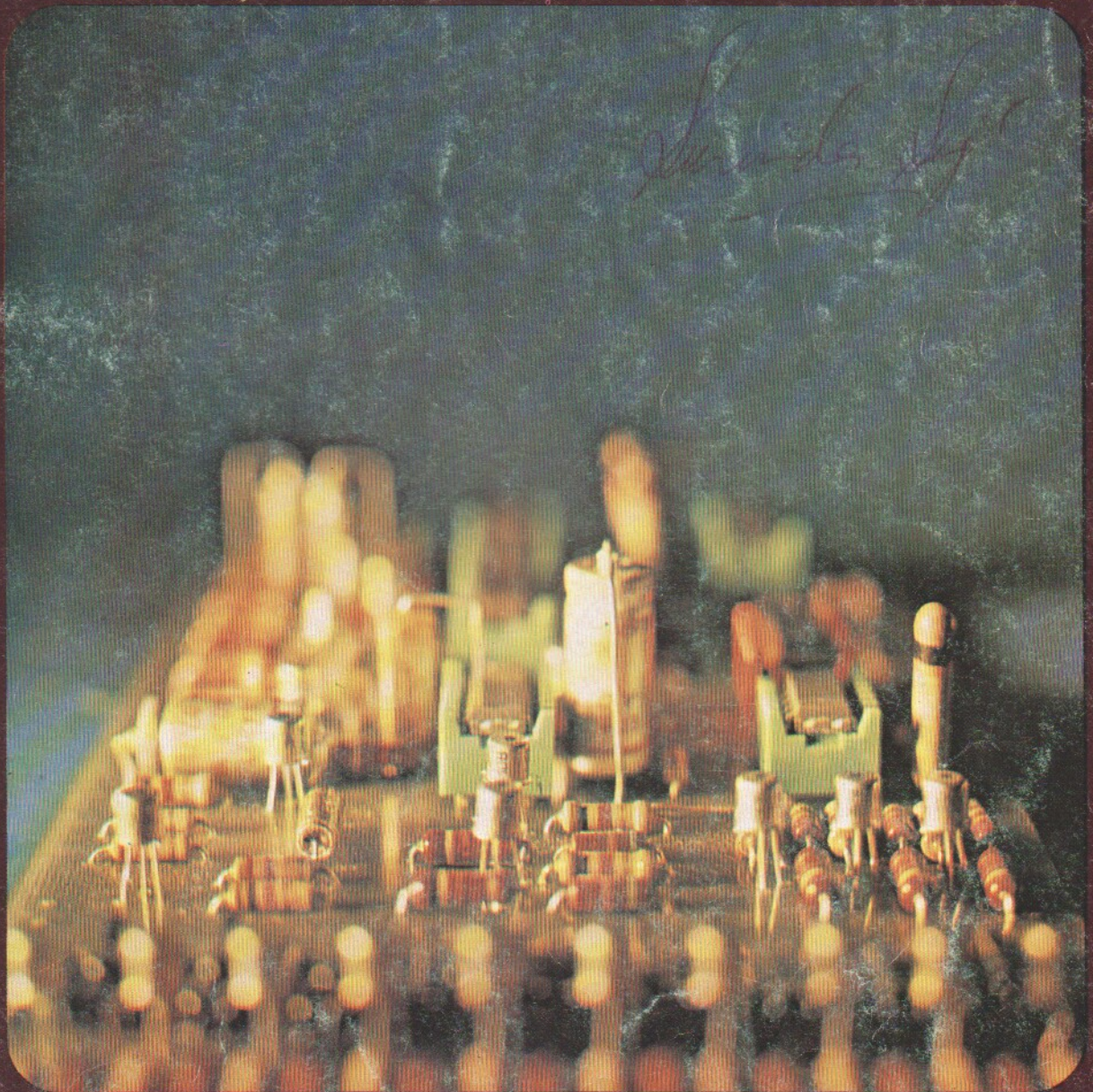



# ELEKTOR

# DECODER

Editor : W. van der Horst

Deputy editor : P. Holmes

Technical editors : J. Barendrecht  
G.H.K. Dam  
E. Krempelsauer  
G.H. Nachbar  
Fr. Scheel  
K.S.M. Walraven

Art editor : C. Sinke

Subscriptions : Mrs. A. van Meyel

UK editorial offices, administration and advertising:  
6 Stour Street, Canterbury, CT1 2XZ.  
Tel. Canterbury (0227) - 54430. Telex: 965504.  
Bank: Midland Bank Ltd Canterbury A/C no. 11014587,  
Sorting code 40-16-11, giro no. 3154254

Assistant Manager and Advertising : R.G. Knapp  
Editorial : T. Emmens

Elektor is published monthly on the third Friday of each month, price 45 pence.  
Please note that number 27/28 (July/August) is a double issue, 'Summer Circuits', price 90 pence.  
Single copies (including back issues) are available by post from our Canterbury office to UK addresses and to all countries by surface mail at £ 0.60  
Single copies by air mail to all countries are £ 0.95  
Subscriptions for 1977 (January to December inclusive): to UK addresses and to all countries by surface mail: £ 6.25, to all countries by air mail £ 11.-.  
Subscriptions for 1977 (March to December inclusive):  
To U.K. addresses and to all countries by surface mail: £ 5.25.  
All prices include p & p.

Change of address. Please allow at least six weeks for change of address. Include your old address, enclosing, if possible, an address label from a recent issue.

Letters should be addressed to the department concerned:  
TQ = Technical Queries, ADV = Advertisements, SUB = Subscriptions; ADM = Administration; ED = Editorial (articles submitted for publication etc.); EPS = Elektor printed circuit board service.  
For technical queries, please enclose a stamped, addressed envelope.

The circuits published are for domestic use only. The submission of designs or articles to Elektor implies permission to the publishers to alter and translate the text and design, and to use the contents in other Elektor publications and activities. The publishers cannot guarantee to return any material submitted to them. All drawing, photographs, printed circuit boards and articles published in Elektor are copyright and may not be reproduced or imitated in whole or part without prior written permission of the publishers.

Patent protection may exist in respect of circuits, devices, components etc. described in this magazine.

The publishers do not accept responsibility for failing to identify such patent or other protection.

National advertising rates for the English edition of Elektor and/or international advertising rates for advertising at the same time in the English, Dutch and German issues are available on request.

Distribution: Spotlight Magazine Distributors Ltd,  
Spotlight House 1, Bentwell Road, Holloway, London N7 7AX.

Copyright © 1977 Elektor publishers Ltd — Canterbury.

Printed in the Netherlands.

What is a TUN?  
What is 10 n?  
What is the EPS service?  
What is the TQ service?  
What is a missing link?

### Semiconductor types

Very often, a large number of equivalent semiconductors exist with different type numbers. For this reason, 'abbreviated' type numbers are used in Elektor wherever possible:

- '741' stands for  $\mu$ A741, LM741, MC741, MIC741, RM741, SN72741, etc.
- 'TUP' or 'TUN' (Transistor, Universal, PNP or NPN respectively) stands for any low frequency silicon transistor that meets the specifications listed in Table 1. Some examples are listed below.
- 'DUS' or 'DUG' (Diode, Universal, Silicon or Germanium respectively) stands for any diode that meets the specifications listed in Table 2.
- 'BC107B', 'BC237B', 'BC547B' all refer to the same 'family' of almost identical better-quality silicon transistors. In general, any other member of the same family can be used instead. (See below.)

For further information, see 'TUP, TUN, DUG, DUS', Elektor 21, p. 160.

Table 1. Minimum specifications for TUP (PNP) and TUN (NPN).

V <sub>CEO</sub> , max	20V
I <sub>C</sub> , max	100 mA
f <sub>hfe</sub> , min	100
P <sub>tot</sub> , max	100 mW
f <sub>T</sub> , min	100 MHz

Some 'TUN's are: BC107, BC108 and BC109 families; 2N3856A, 2N3859, 2N3880, 2N3904, 2N3947, 2N4124. Some 'TUP's are: BC177 and BC178 families; BC179 family with the possible exception of BC159 and BC179; 2N4212, 2N3251, 2N3906, 2N4126, 2N4291.

Table 2. Minimum specifications for DUS (silicon) and DUG (germanium).

	DUS	DUG
V <sub>R</sub> , max	25V	20V
I <sub>F</sub> , max	100mA	35mA
I <sub>R</sub> , max	1 $\mu$ A	100 $\mu$ A
P <sub>tot</sub> , max	250mW	250mW
C <sub>D</sub> , max	5pF	10pF

Some 'DUS's are: BA127, BA217, BA218, BA221, BA222, BA317, BA318, BA313, BAY61, 1N914, 1N4148.  
Some 'DUG's are: OA85, OA91, OA95, AA116.

BC107 (-8, -9) families:  
BC107 (-8, -9), BC147 (-8, -9), BC207 (-8, -9), BC237 (-8, -9), BC317 (-8, -9), BC347 (-8, -9), BC547 (-8, -9), BC171 (-2, -3), BC182 (-3, -4), BC382 (-3, -4), BC437 (-8, -9), BC414

### BC177 (-8, -9) families:

BC177 (-8, -9), BC157 (-8, -9), BC204 (-5, -6), BC307 (-8, -9), BC320 (-1, -2), BC350 (-1, -2), BC557 (-8, -9), BC251 (-2, -3), BC212 (-3, -4), BC512 (-3, -4), BC261 (-2, -3), BC416.

### Resistor and capacitor values

When giving component values, decimal points and large numbers of zeros are avoided wherever possible. The decimal point is usually replaced by one of the following international abbreviations:

p (pico-) = 10<sup>-12</sup>  
n (nano-) = 10<sup>-9</sup>  
 $\mu$  (micro-) = 10<sup>-6</sup>  
m (milli-) = 10<sup>-3</sup>  
k (kilo-) = 10<sup>3</sup>  
M (mega-) = 10<sup>6</sup>  
G (giga-) = 10<sup>9</sup>

### A few examples:

Resistance value 2k7: this is 2.7 k $\Omega$ , or 2700  $\Omega$ .

Resistance value 470: this is 470  $\Omega$ .

Capacitance value 4p7: this is 4.7 pF, or

0.000 000 000 004 7 F ...

Capacitance value 10n: this is the international way of writing 10,000 pF or .01  $\mu$ F, since 1 n is 10<sup>-9</sup> farads or 1000 pF.

### Mains voltages

No mains (power line) voltages are listed in Elektor circuits. It is assumed that our readers know what voltage is standard in their part of the world! Readers in countries that use 60 Hz should note that Elektor circuits are designed for 50 Hz operation. This will not normally be a problem; however, in cases where the mains frequency is used for synchronisation some modification may be required.

### Technical services to readers

- **EPS service.** Many Elektor articles include a lay-out for a printed circuit board. Some — but not all — of these boards are available ready-etched and predrilled. The 'EPS print service list' in the current issue always gives a complete list of available boards.

### - Technical queries.

Members of the technical staff are available to answer technical queries (relating to articles published in Elektor) by telephone on Mondays from 14.00 to 16.30.

Letters with technical queries should be addressed to: Dept. TQ. Please enclose a stamped, self addressed envelope; readers outside U.K. please enclose an IRC instead of stamps.

- **Missing link.** Any important modifications to, additions to, improvements or corrections in Elektor circuits are generally listed under the heading 'Missing Link' at the earliest opportunity.

# CONTENTS

Volume 3

Number 2

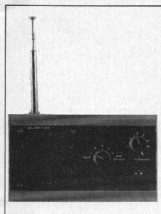

Since a 'local' radio does not require extreme sensitivity or image rejection, the design can be kept simple and no alignment is required.

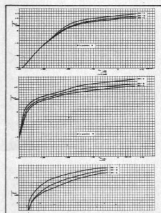

Transfer characteristics of the dynamic range compressor for the three different positions of S1.

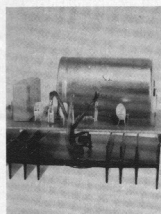

A practical IC power supply suitable for use in equipment or as a laboratory supply need not be much larger than the heatsink.



As many electronics enthusiasts will have heard from the uninitiated: 'I don't know what it is, but it looks pretty'.

selektor ..... 2-08

missing link ..... 2-10

coming soon ..... 2-10

'local' radio ..... 2-12

This simple FM receiver is designed to pick up the local VHF radio stations and makes an ideal 'second set' for use in the kitchen, bedroom, workshop or garage. The circuit is very simple to build and requires no alignment.

sawtooth generator ..... 2-17

Sawtooth signals can be useful for test purposes. This simple circuit will generate a sawtooth over the range 50 mHz to 50 kHz.

hi-fi dynamic range compressor ..... 2-18

The dynamic range compressor provides truly high fidelity performance. It can accept nominal signal levels from 600  $\mu$ V to 2.2 V and is thus suitable for use with microphones as well as higher output circuits such as audio preamps. The harmonic distortion is below 0.3% and the decay of the compressor can be adjusted to suit different types of programme material.

ic power supply ..... 2-26

Three terminal, IC, fixed voltage regulators are now commonplace, and most readers will be familiar with the LM309 and similar devices. Now an IC regulator is available that combines the convenience of the three terminal device with the versatility of a variable voltage regulator.

mini-phase - R. Otterwell ..... 2-31

The mini-phase is a low-cost, simple but effective phasing unit for the musician.

elektorscope (3) ..... 2-32

In the final part of this article the channel-switching logic and the motherboard are described. The latter provides the interconnections between, and power supplies to, the timebase and Y preamps boards. General constructional details are given, with testing and calibration procedures.

emitter follower with current source ..... 2-44

16 channel taps ..... 2-44

Two designs for Touch Activated Programme switches (TAPs) having 16 positions.

mind-bender - K. v. Dellen ..... 2-47

Essentially, Mastermind is a game for one player and a dummy. For this reason, several people have designed electronic versions of the game. One of the simplest versions is described here, requiring 'only' some 40 TTL IC's. For the keen Mastermind player, this minor drawback is offset by the fact that it provides him with an opponent who doesn't get impatient if he takes too long over a move.

TBA 120 T ..... 2-50

market ..... 2-52





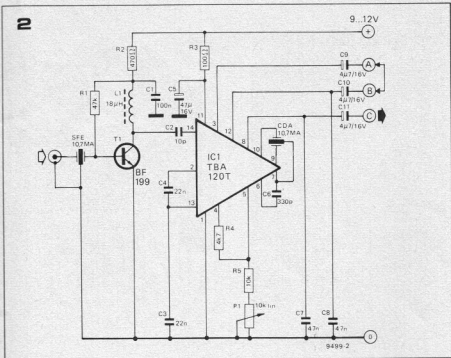
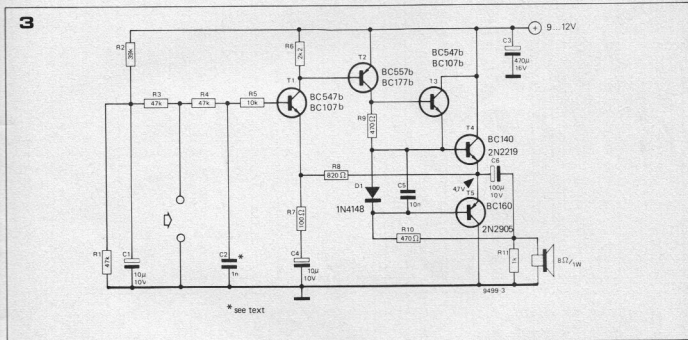

Figure 1. Circuit of the front end, which requires no alignment.

Figure 2. The i.f. strip, which uses a ceramic i.f. filter to provide selectivity, and a ceramic phase shifter in place of the quadrature coil.

Figure 3. Circuit of the a.f. amplifier, which operates with zero quiescent current.

Figure 4. Circuit of the power supply, which uses an IC regulator.



\* see text

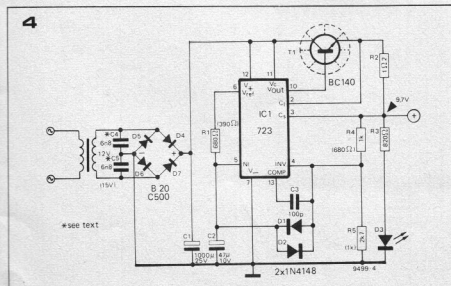

\* see text

### Construction

Printed circuit boards and component layouts for the front-end, i.f. amplifier, a.f. amplifier and power supply are given in figures 5 to 8 respectively. The large number of inductors in the front-end may seem to be a problem, but these can be obtained ready-wound from suppliers who advertise in Elektor. The circuit is built on four separate boards so that the individual sections could, if required, be used in other projects. In particular the power supply and a.f. amplifier are very useful units in their own right. It will be noted that provision is made for replacing P1 by a preset mounted on the i.f. amplifier board for applications not requiring a front panel gain control.

Figure 9 shows the complete wiring diagram of the receiver. To avoid hum,

interference or instability problems this should be carefully followed. The front-end should be mounted in a metal box for screening purposes and the aerial should be connected to the front-end by the shortest possible length of  $75\Omega$  coax. The only connections to chassis and hence to mains earth should be at the input to the front-end, to the screening box, at the input of the i.f. amplifier, and to the mains transformer screen connection if provided. C4 and C5 in the power supply are optional. If hum problems occur due to switching spikes caused by D4 - D7 then C4 and C5 can be mounted across D5 and D6 on the back of the p.c. board.

Before making the connections to the output of the power supply the output voltage should be checked to ensure that it is approximately correct. This will avoid any possibility of damage to the rest of the circuit. The supply may then be connected and the test point voltages on the a.f. amplifier measured. Assuming these are correct it should be possible to tune in stations by adjusting the tuning pot. It is perhaps worth noting at this point that the tuning pot. should be a good quality component, otherwise noise may be generated when it is rotated, making tuning difficult. If a slight crackle does occur then it may be reduced by decoupling the slider of the tuning pot. with a  $1\mu 5$  capacitor to the 0 V rail, though this will make the tuning voltage sluggish in following the movements of the pot.

### Performance

The performance of such a simple design cannot be expected to be revolutionary. Nevertheless the sensitivity for a 26 dB signal-to-noise ratio is only  $10\mu\text{V}$ , which is quite adequate for the intended application. Due to the lack of selectivity in the front-end the image rejection is not very high, being about 15 dB.

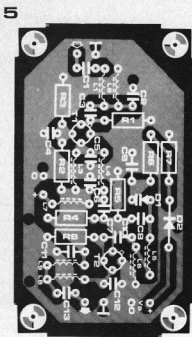

Parts list for figure 1

#### Resistors:

R1 = 1k5  
R2,R3,R5,R7 = 10 k  
R4 = 27 k  
R6 = 100 k

#### Capacitors:

C1 = 22 p  
C2 = 68 p  
C3,C13 = 1 n  
C4,C6,C9 = 10 n  
C5,C8,C12 = 10 p  
C7 = 2p7  
C10 = 1n5  
C11 = 100 n

#### Semiconductors:

T1 = BF180  
T2 = BF185  
D1 = BB105 (varicap)  
D2 = 1N4148

#### Coils:

L1,L2,L5,L6 = 0.15  $\mu\text{H}$   
L3 = 0.22  $\mu\text{H}$   
L4 = 1  $\mu\text{H}$   
L7,L9 = 100  $\mu\text{H}$   
L8 = 18  $\mu\text{H}$

#### External components:

18 k resistor  
4k7 resistor  
47 k log potentiometer  
470  $\mu\text{F}$  16 V electrolytic capacitor

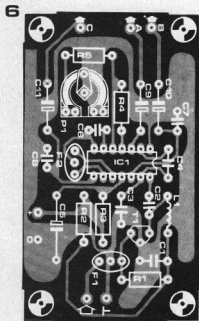

Parts list for figure 2

#### Resistors:

R1 = 47 k  
R2 = 470  $\Omega$   
R3 = 100  $\Omega$   
R4 = 4k7  
R5 = 10 k

#### Capacitors:

C1 = 100 n  
C2 = 10 p  
C3,C4 = 22 n  
C5 = 47  $\mu\text{F}$  16 V  
C6 = 330 p  
C7,C8 = 47 n  
C9,C10,C11 = 4  $\mu\text{F}$  16 V

#### Semiconductors:

T1 = BF 199  
IC1 = TBA 120 T

#### Miscellaneous:

L1 = 18  $\mu\text{H}$  choke  
P1 = 10 k lin potentiometer  
ceramic filter SFE 10,7 MA  
ceramic phase shifter CDA 10,7 MA



Figure 5. Printed circuit board and component layout for the front end (EPS 9512A)

Figure 6. Printed circuit board and component layout for the i.f. amplifier (EPS 9689)

Figure 7. Printed circuit board and component layout for the a.f. amplifier (EPS 9499-1).

Figure 8. Printed circuit board and component layout for the power supply. (EPS 9499-2)

Figure 9. Wiring diagram for the complete receiver. Note that P1 is not a preset but is a normal pot wired to the board.

7

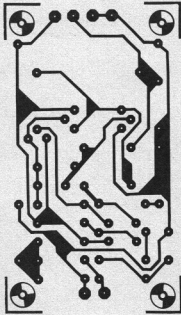
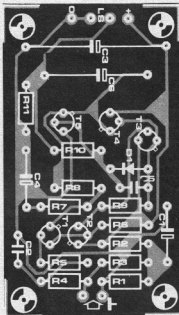

Parts list for figure 3

Resistors:

- R1,R3,R4 = 47 k
- R2 = 39 k
- R5 = 10 k
- R6 = 2k2
- R7 = 100 Ω
- R8 = 820 Ω
- R9,R10 = 470 Ω
- R11 = 1 k

Capacitors:

- C1 = 10 μ/10 V
- C2 = 1 n (see text)
- C3 = 470 μ/16 V
- C4 = 10 μ/10 V
- C6 = 100 μ/10 V
- C5 = 10 n

Semiconductors:

- T1,T3 = BC 107B, BC 547B
- T2 = BC 177B, BC 557B
- T4 = BC 140, 2N2219
- T5 = BC 160, 2N2905
- D1 = 1N4148

8

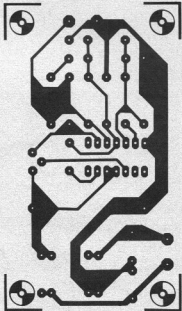
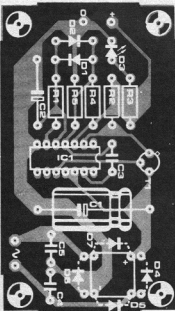

Parts list for figure 4

Resistors:

- R1 = 680 Ω
- R2 = 1Ω
- R3 = 820 Ω
- R4 = 1 k
- R5 = 2k7

Capacitors:

- C1 = 1000 μ/25 V
- C2 = 47 μ/10 V
- C3 = 100 p
- C4,C5 = 6n8

Semiconductors:

- IC1 = 723
- T1 = BC 140
- D1,D2 = 1N4148
- D3 = LED
- D4...D7 = Bridge rectifier  
minimum rating 12 V 500 mA

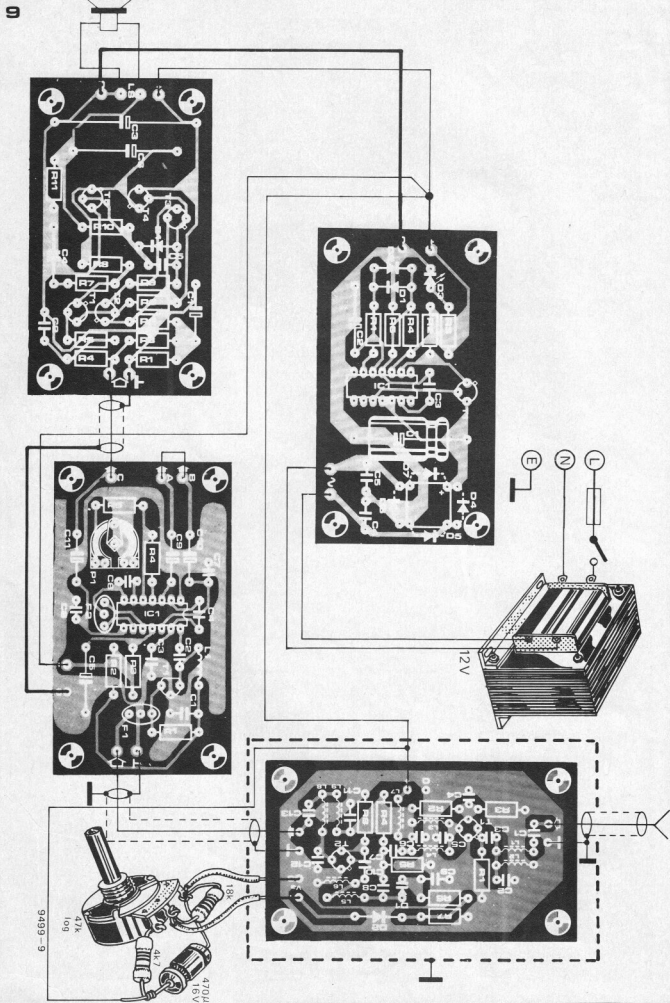



# SAWTOOTH GENERATOR

Sawtooth signals can be useful for test purposes in audio and other circuits, but few signal generators (except expensive ones) provide a sawtooth output. This simple circuit will generate a sawtooth over the range 50 mHz to 50 kHz.

The simple generator described in this article will generate a linear repetitive ramp (sawtooth) waveform from sub-sonic to ultrasonic frequencies. The circuit, shown in figure 1, uses only five transistors and few other components.

T1 is connected as a constant current source and since T5/T4 present a high input impedance almost all this current flows into  $C_X$ , charging it so that the voltage across  $C_X$  rises linearly. The base voltage of T2 is set to about 9.9 volts by R3 and R4, so T2 and T3 are normally turned off. When the voltage across  $C_X$  (and hence on the emitter of T2) rises to about 10.5 V T2 turns on. Positive feedback from the collector of T2 to the base of T3 turns on T3 and positive feedback from the collector of T3 keeps T2 turned on.  $C_X$  rapidly discharges through T2 and T3, these transistors turn off and the cycle repeats. The compound emitter follower T5/T4 buffers the output and the output voltage may be adjusted by P2. P1 varies the charging current into  $C_X$  and hence provides fine control of the repetition frequency.

Since R3 and R4 determine the voltage at which T2 turns on they may be altered to set the maximum output voltage of the generator. The maximum output is given by:

$$V_{out\ max} = \frac{V_{supply} \times R_4}{R_3 + R_4}$$

From this it is apparent that the output voltage is also dependent on supply voltage, so this should be stabilised to avoid output voltage variations.

The repetition frequency of the sawtooth is given by:

$$f \approx \frac{I_{C_X}}{\sqrt{C_X \max} \cdot C_X} \\ \approx \frac{V_f}{R_1 + P_1} \\ \approx \left( \frac{V_{supply} \cdot R_4}{R_3 + R_4} + V_f \right) C_X$$

Where  $V_f$  is a diode forward voltage drop (about 600 mV).

The value of P1 may, of course, be varied between zero and 10 k. P1 can, however, vary the frequency only over a 10:1 range, so to obtain a wider range different values of  $C_X$  must be switched in. Table 1 gives values of  $C_X$  for six decade frequency ranges from 50 mHz to 50 kHz. However it should be noted that on the lowest frequency range (where  $C_X$  must be an electrolytic) the frequency range covered may deviate from that given due to the large tolerance of electrolytic capacitors. **M**

Table 1

$C_X$	Frequency Range
100 $\mu$ /16 V	50 mHz to 500 mHz
10 $\mu$ /16 V	500 mHz to 5 Hz
1 $\mu$ /16 V	5 Hz to 50 Hz
100 n	50 Hz to 500 Hz
10 n	500 Hz to 5 kHz
1 n	5 kHz to 50 kHz

Figure 1. Circuit of the sawtooth generator.

Table 1. Values of  $C_X$  for six frequency ranges.

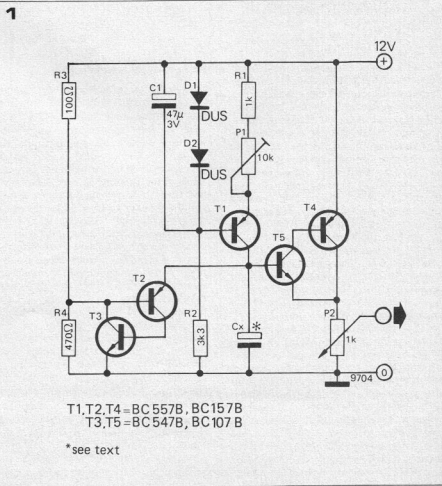

# HI-FI DYNAMIC RANGE COMPRESSOR

Several designs for dynamic range compressors have previously been published in Elektor, but this is the first design that provides truly high-fidelity performance. It can accept nominal signal levels from 600  $\mu\text{V}$  to 2.2V and is thus suitable for use with microphones as well as higher output circuits such as audio preamps. The harmonic distortion is below 0.3% and the decay of the compressor can be adjusted to suit different types of programme material.

Dynamic range compressors find many applications. The recording industry would be unable to make a single disc without some method of compressing the dynamic range of the programme. The reasons for this are fairly obvious. The dynamic range of live music, from the softest ppp of the piccolo to the loudest fff of the bass drum can be in excess of 80 dB. However, even the best recording media have a usable dynamic range of only 60 dB or so. The smallest signal level that can be recorded on tape is limited by tape noise, while the largest signal level is limited by tape saturation. In the case of disc the lowest signal level is limited by surface noise and the highest signal level is limited by the tracking ability of the cartridge.

At the other end of the recording chain compressors are very useful in discotheques to compress the dynamic range of the recording still further and so maintain a fairly high average signal that can be heard above the background noise (of people conversing in shouts) without the danger of the equipment overloading on peaks. Compressors can also be used in home-tape recording, public-address systems and by radio amateurs, to name but a few applications.

## Principles of compressors

Although most compressors operate according to the same broad principles the compression characteristics may vary widely depending upon the intended application. For example, the 'limiters' found in some tape recorders do very little at all to the signal until the signal level approaches tape saturation, but they then operate in a very heavy-handed manner to ensure that the signal does not exceed tape saturation level. Compressors intended for P.A. systems, on the other hand, begin to operate at a very low signal level to try to maintain a fairly constant signal level for maximum intelligibility. The only real difference between these two types is the threshold level at which they begin to operate.

Compressors with pretensions to high-fidelity, on the other hand, apply compression over the entire dynamic range of the signal, rather than simply clamping all signals which exceed a certain level.

However, these systems all have several things in common. Figure 1 shows a block diagram of a generalised compression system. The input signal passes through a voltage (or current) controlled attenuator followed by an am-

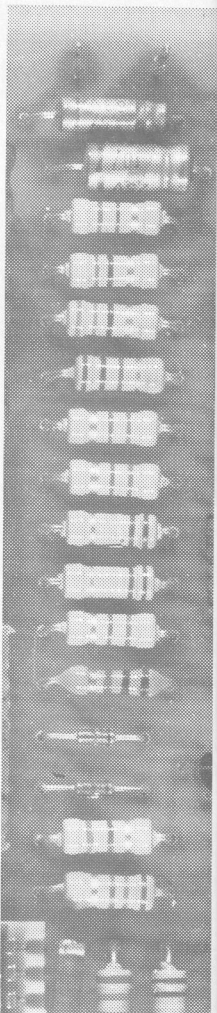



1

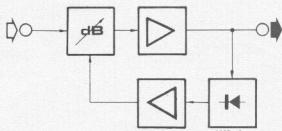

2b

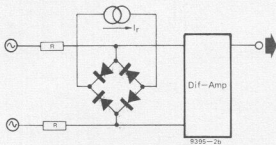

plifier. The amplified output is rectified, DC amplified and used to control the attenuator. Thus, as the input signal increases so will the control voltage applied to the attenuator and hence the degree of attenuation, so that, instead of the output increasing in a linear fashion proportional to the input, the increase in the output signal becomes smaller as the input signal increases. Of course, the control voltage applied to the attenuator must not be the 'raw' output of the rectifier, since the attenuation would then vary during each cycle of the signal waveform, leading to gross distortion. The output of the rectifier must be 'smoothed' to give a control voltage that will follow the envelope of the waveform, but not each individual cycle.

This inevitably leads to compromises in the design. If the control voltage has a long time constant then the compressor will be unable to respond to sudden changes in signal level, while if it is too short the signal will be distorted, especially at low frequencies. Fortunately an interesting psychoacoustic effect can be used to advantage. The ear is insensitive to distortion during sudden increases in signal level, so the attack time constant of the control voltage can be made fairly short. This can be important in preventing equipment overloads. The decay time constant however, must be relatively long to prevent the control voltage following the signal waveform, and this of course means that, should the signal level suddenly decrease, it will be some time before the attenuation is reduced, causing intervals when the signal may be much too quiet. In the present design this problem is reduced by providing three different decay time constants; a short (120 ms)

3a

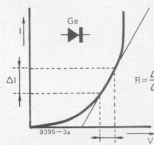

3b

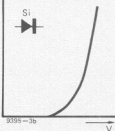

Figure 1. Block diagram of a dynamic range compressor.

Figure 2a. Basic current-controlled diode attenuator.

Figure 2b. Bridge type diode attenuator with differential signal input and output to reject the common-mode control voltage.

Figure 3a. Forward transfer characteristic of a germanium diode.

Figure 3b. Forward transfer characteristic of a silicon diode.

2a

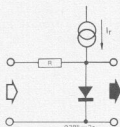

time constant suitable for speech, where signal levels fluctuate rapidly and distortion is less important than intelligibility; a medium time constant (600 ms) suitable for mixed (speech and music) programmes, and a long (3 sec) time constant for music, where distortion is more important than the occasional quiet passage.

### Controlled Attenuator

Many non-linear devices could be used as the control elements in the attenuator, for example field effect transistors, voltage dependent resistors or light dependent resistors, but one of the cheapest and most effective solutions is an attenuator using silicon or germanium diodes.

The forward conduction characteristics of a germanium and a silicon diode are shown in figures 3a and 3b respectively.

It will be seen that the dynamic resistance of a diode  $\Delta V / \Delta I$ , decreases as the

current through the diode increases.

This can be put to use in an attenuator as shown in figure 2a. The diode forms the lower limb of a potential divider and is fed by a current source  $I_r$ . A current source is used since it has an infinite output impedance and cannot, of itself, attenuate the signal. If the control current through the diode is increased the diode resistance will fall and the attenuation of the signal will increase. This simple circuit has several disadvantages. Firstly, the control current, as well as varying the dynamic resistance of the diode, also causes a voltage drop which is superimposed on the signal. Changes in this voltage as the control current varies can give rise to clicks and thumps. This problem can be overcome by arranging four diodes in a bridge configuration as shown in figure 2b. The signal is applied differentially and is amplified by the differential amplifier at the output of the attenuator, but the voltage produced by the control current appears in common mode at each of the differential amplifier inputs, and is thus rejected.

The second problem with the diode attenuator is that the signal voltage causes a current to flow through the diode, which varies the dynamic resist-



Figure 4. The complete circuit of one channel of the dynamic range compressor.

Figure 5. Transfer characteristic of the compressor for the three different positions of S1.

also to avoid overloading the rectifier output.

## Test Results

Figures 5a to 5c illustrate the transfer characteristic of the compressor with S1 in the low, medium and high gain positions respectively. The signal levels are plotted in dB relative to 0dB = 1 volt. It can be seen that the position of S2 has a very slight effect on the transfer characteristic. This is caused by the different loading of the rectifier.

Figures 6a to 6c show the frequency response of the compressor with S1 in its three different positions. Here the gain in dB at the input levels specified is plotted against frequency on a logarithmic scale. It will be noted that the gain with S1 in position C is rolled off below about 200 Hz by the increasing impedance of C10. This setting of S1 is intended principally for microphone inputs for speech use. Rolling off the gain at low frequencies does not impair intelligibility, but it does help to minimise hum pickup, flicker noise from T1, and thumps and rumbles caused by handling the microphone.

The final tests performed on the compressor were the measurement of decay with S2 in its three different positions. This is shown in figures 7a to 7c. The test method used was to feed a low level signal into the compressor, with bursts of a much higher amplitude superimposed upon it. In each case the input signal is the lower trace of the oscillogram.

In figure 7a it can be seen that the output signal level rises quickly at the start of the tone burst. This is due to the delay in the operation of the compressor caused by the attack time constant. As C14 charges, however, the amplitude is quickly controlled. At the end of the tone burst the amplitude of the output signal falls below what it was before the tone burst, then slowly recovers. In fact, comparing figure 7a with figures 7b and c it can be seen that it does not regain its original level before the next tone burst arrives. In figures 7b and 7c it can be seen that the signal recovers its original amplitude much more rapidly due to the shorter decay time constant. Figure 7c shows the whole sequence particularly well; the initial amplitude of the output before the tone burst, then the overshoot at the start of the toneburst, quickly controlled; the drop in amplitude at the end of the tone burst and finally recovery to the original output level.

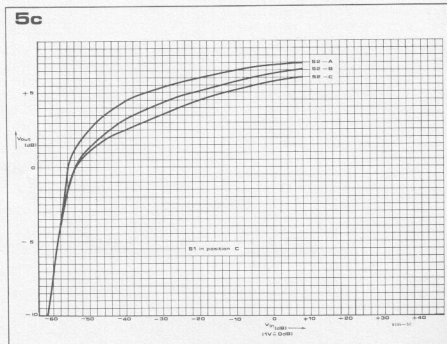
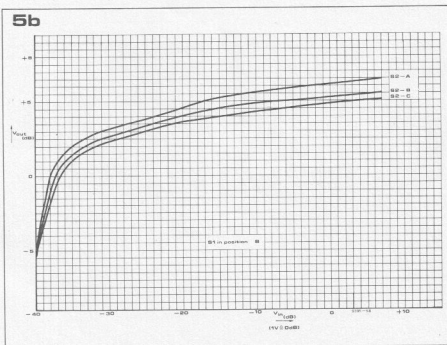
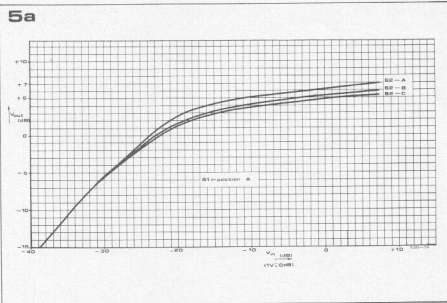



### Distortion figures

Because of the many variables involved, such as decay time constant, input signal level and frequency, it is difficult to give comprehensive results for distortion. Obviously, higher distortion figures are to be expected at higher input levels due to interaction of the signal with the control current through the attenuator. Distortion might also be expected to be worse at lower frequencies and/or faster decay time constants.

However, to give a typical example, with S1 in position B and with the nominal input level of 50mV the harmonic distortion was less than 0.3% over most of the audio spectrum. To give a worst case example, with S1 in position C (maximum gain) and an input level of 500 mV (40 dB greater than the nominal input level), the distortion was still less than 1%. This compares very favourably with commercially available compressors, which often introduce up to 10% distortion.

### Construction

Since the compressor is intended for high-fidelity applications (which almost invariably means stereo) a two-channel board layout was designed. This also facilitates some interesting applications, which will be discussed later. The printed circuit board and component layout are given in figures 8 and 9. If the unit is to be used for straightforward stereo recording or reproduction then S1 and S2 should be double-pole three-way types. Otherwise refer to the section headed applications. Apart from this construction of the printed circuit board is extremely simple. Wiring of the unit into an audio system should conform to normal audio practice, with screened leads being used for inputs, outputs and connections to switches. Care should be taken to avoid earth loops, and the inputs of the compressor should be kept well away from mains transformers and/or the outputs of power amplifiers.

### Applications

The provision of a link on the board between points X and Y, as well as being a break point in the feedback loop for test purposes, also makes possible some interesting applications. One example is a voice operated fader, shown in figure 10.

One channel of the compressor is fed from a microphone, the other from a music source such as disc or tape. The control output of the microphone channel is fed to the controlled attenuator input of the music channel, so that as soon as someone speaks into the microphone the level of the music is lowered — very useful for disc jockeys. For this application separate switches are required for S1 in each channel, since S1 will be set to maximum gain for the mic channel, but will be in either the medium or low gain position in the

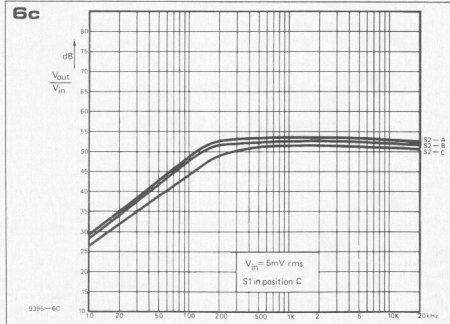
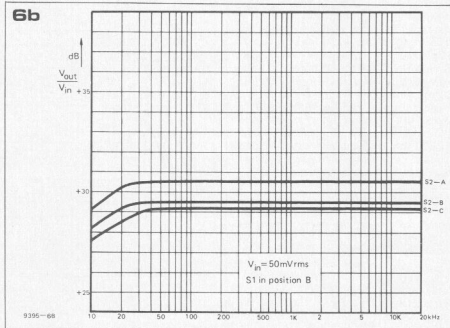
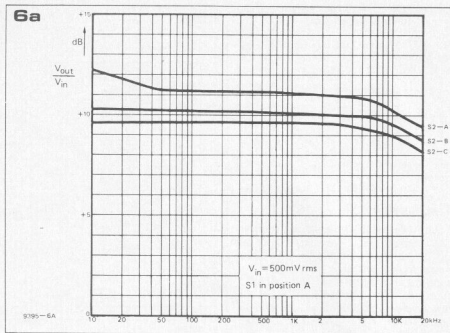

## Parts list (For one channel)

## Resistors:

R1, R4, R8, R9, R13 = 47 k  
 R2, R25, R26 = 100 k  
 R3 = 1 k  
 R5 = 5k6  
 R6, R27, R28 = 220  $\Omega$   
 R7, R23, R24 = 4k7  
 R10, R11, R18, R21 = 220 k  
 R12 = 10 k  
 R14, R15 = 1k5  
 R16 = 15 k  
 R17 = 150  $\Omega$   
 R19, R22 = 2k2  
 R20 = 22 k  
 R29 = 6k8  
 R30 = 33 k  
 R31 = 150 k  
 R32 = 470  $\Omega$

## Capacitors:

C1, C4, C5, C6, C7,  
 C12, C13 = 1 $\mu$ 5/25 V  
 C2 = 470  $\mu$ /25 V  
 C3, C8 = 10  $\mu$ /25 V  
 C9 = 1 n  
 C10 = 270 n  
 C11 = 22  $\mu$ /25 V  
 C14 = 22  $\mu$ /3 V  
 C15 = 100  $\mu$ /25 V

## Semiconductors:

T1 ... T4 = BC 559 C  
 T5 ... T8 = BC 547 B, BC 107 B  
 T9 = BC 557 B, BC 177 B  
 D1/D3, D2/D4 = AA 119 matched pairs  
 D5, D6, D7 = 1N4148 (1N914)  
 IC1 =  $\mu$ A 739, SN 76131,  
 TBA 231, MC 1303

## Miscellaneous:

S1, S2 Mono: single pole three way.  
 Stereo: double pole three way.

7a

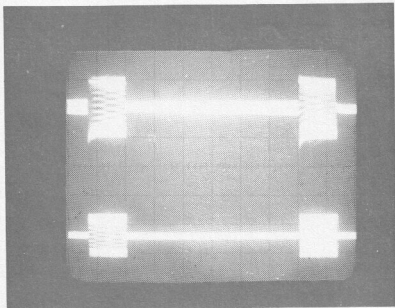

7b

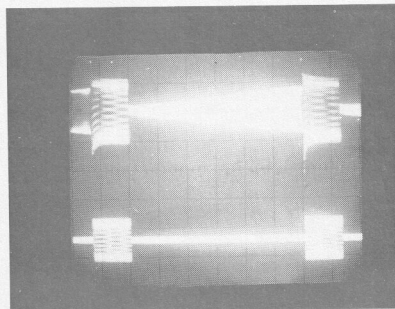

7c

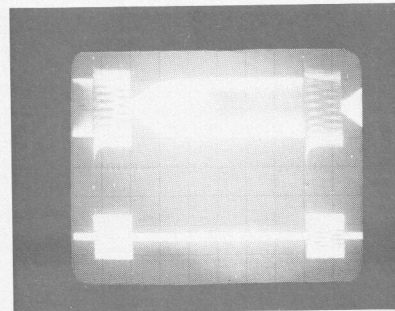
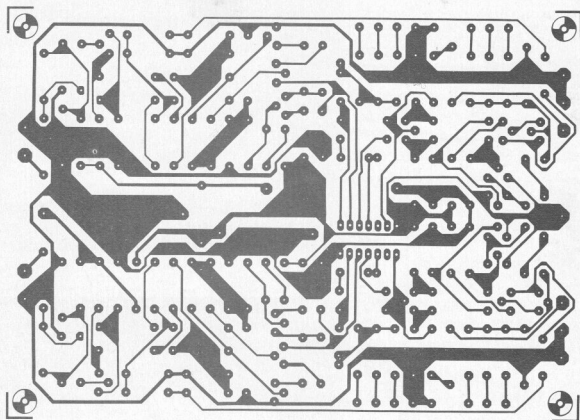

Figure 6. Gain/Frequency plot of the compressor at specified input levels for the three positions of S1.

Figure 7. Oscillograms showing the response to toneburst signals with different settings of S2.

8



9

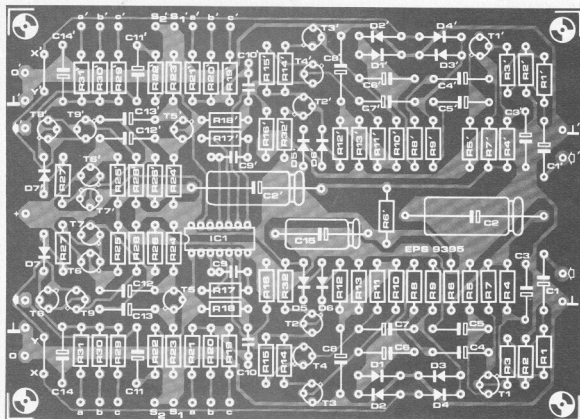



hi-fi dynamic range compressor

Figure 8 and 9. Printed circuit board and component layout for a stereo version of the compressor. (EPS 9395)

Figure 10. By linking the control output of one channel to the attenuator input of the other channel the compressor can be used as a voice operated fader.

Figure 11. For stereo operation the control circuits of both channels should be linked to avoid shifts of the stereo image.

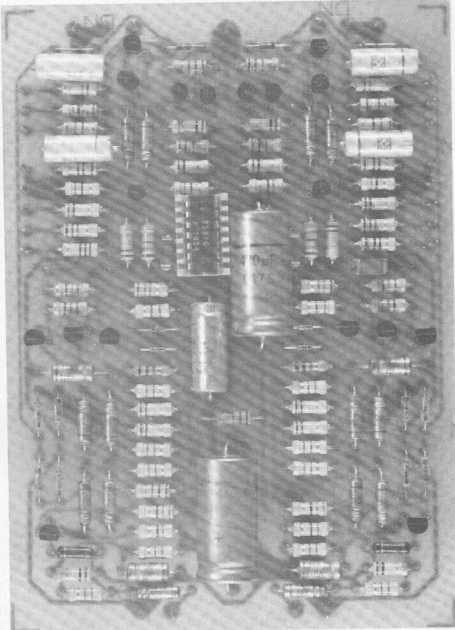

other channel. S2 will be required in the microphone channel, but will not be required in the music channel. Many variations on this theme can be constructed, limited only by the ingenuity of the reader. For example, the system could be extended so that the microphone could fade several channels. The link between points X and Y in the microphone channel could be omitted so that this channel functioned simply as a microphone preamp, while the link between points X and Y in the music channel could be included, so that the compressor would be controlled either by the microphone or by the music signal.

**Stereo Use**

For stereo use it is important that points X and Y in both channels should be linked as shown in figure 11 so that the compressors operate 'in unison'. If the two channels are not linked in this manner some disturbing shifts of the stereo image may occur. For example, consider an orchestra arranged around a stage with a soloist centre. While the left and right-hand sections of the orchestra were playing at about the

same level no problem would occur. The solo would emanate equally from both loudspeakers and would thus appear central. If, however, a crescendo occurred in the left-hand section of the orchestra then the left-hand compressor would operate, compressing all the left channel signal

including the soloist. The image of the soloist would thus shift to the right, giving the impression that he or she was roller skating around the stage. With the control circuits linked a change in signal level in one channel will vary the attenuation of both channels, and the stereo image will be unaffected.

10

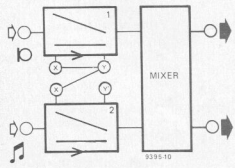

11

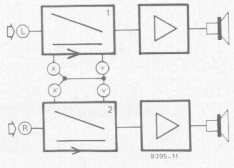

# IC POWER SUPPLY

Three terminal, IC, fixed voltage regulators are now commonplace, and most readers will be familiar with the LM309 and similar devices. Now an IC regulator is available that combines the convenience of the three terminal device with the versatility of a variable voltage regulator.

The LM317 from National Semiconductor is available in the familiar TO-3 or TO-5 packages, the two versions being suffixed 'K' and 'H' respectively. The pinout of the ICs is given in figure 1. Unlike the more familiar fixed voltage regulators one pin is not connected to ground. The LM317 operates on the floating regulator principle and pin 1 carries a control voltage that sets the output potential.

Since no part of the IC is connected to ground it is possible for the LM317 to regulate quite high voltages, provided the maximum input-output differential of the IC is not exceeded.

The absolute maximum ratings and principal electrical characteristics of the LM317 (and extended temperature range versions LM117 and LM217) are given in Table 1. Of particular interest are the high output current (typically 2.2 A for the TO-3 package) and the ripple rejection of 65 dB, which may be

improved to 80 dB as will be discussed later.

Figure 2 shows the basic applications circuit for the LM317. Resistors R1 and R2 set the reference voltage at the control node pin 1 and hence the output voltage. A reference voltage of approximately 1.25 V is available between pins 3 and 1. This produces a constant current that flows through R1 and hence through R2. However, a leakage current of approximately 100  $\mu$ A flows out of pin 1 through R2, so that the output voltage is given by the equation

$$V_{out} = V_{ref} \left( 1 + \frac{R_2}{R_1} \right) + I_L R_2$$

In practice the minimum load current at which the LM317 will regulate is about 4 mA. At load currents lower than this the output voltage will rise above the desired value. This means that R1 should be 270 $\Omega$  or less to

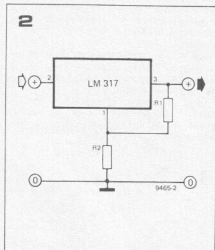

ensure a load current greater than 4 mA. The 100  $\mu$ A leakage current then amounts to less than 2% of this and can be neglected. R2 may then be calculated from the equation:

$$R_2 = \frac{(V_{out} - V_{ref}) R_1}{V_{ref}}$$

$$\text{e.g. } \frac{(V_{out} - 1.25) 270}{1.25}$$

Of course, the value of the output voltage may not be exactly that calculated due to the tolerance of the reference voltage and if a precise output voltage is required then it will be necessary to make R2 adjustable. The performance of the regulator may be improved by the addition of a few more external components, as shown in figure 3. If the regulator is not mounted close to the reservoir capacitor then a 1 $\mu$ F tantalum decoupling capacitor may be required between pin 2 and ground, mounted close to the IC. The ripple rejection may be increased up to 80 dB by a 10 $\mu$ F tantalum capacitor between pin 1 and ground, decoupling the control voltage. Its effect is shown in figures 4 and 5. A small decoupling capacitor may also be added at the output.

Figure 6 shows the response of the circuit to a line transient with (dotted) and without the decoupling capacitors. It can be seen that when decoupling capacitors are used the transient is much better controlled.

## Protection Diodes

If a short-circuit occurred on the input or output it would be possible for C2 and C3 to discharge through the IC, causing damage. Diodes D1 and D2 provide a path for the capacitors to discharge harmlessly to ground in the event of such a short-circuit.

## Variations on a theme

Provision of a control pin on the LM317 provides some interesting possibilities for variations on the basic regulator

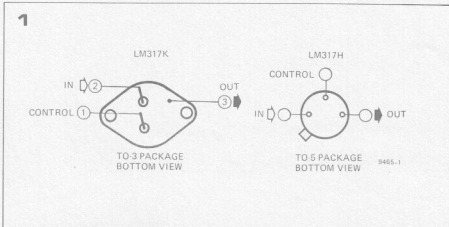

Figure 1. Pinout of the LM317H and LM317K

Figure 2. Showing how the output voltage of the LM317 can be set with two resistors.

Table 1. Absolute maximum ratings and electrical specifications of the LM317.

circuit. For instance, remote shutdown can be achieved by connecting an NPN transistor between the control pin and ground, as shown in figure 7. Turning on the transistor grounds the control input, lowering the output voltage to a little above  $V_{ref}$ . If a power supply with a slow switch-on risetime is required then this may be accomplished as shown

in figure 8. When the power is applied C2 charges through the base-emitter junction of T1, turning on this transistor, which grounds the control pin. As C2 charges the current through T1 diminishes and the output voltage slowly rises.

Another interesting possibility is to use the IC as a current source. If a resistor is

## 1a

Table 1

## absolute maximum ratings

Power Dissipation	Internally limited
Input-Output Voltage Differential	40 V
Operating Junction Temperature Range	
LM117	-55°C to +150°C
LM217	-25°C to +150°C
LM317	0°C to +125°C
Storage Temperature	-65°C to +150°C
Lead Temperature (Soldering, 10 seconds)	300°C

## 1b

## electrical characteristics (Note 1)

Parameter	Conditions	LM117/217			LM317			units
		min	typ	max	min	typ	max	
Line Regulation	$T_A = 25^\circ\text{C}$ , $3\text{V} < V_{in} - V_{out} < 40\text{V}$ (Note 2)		0.01	0.02		0.01	0.04	%/V
Load Regulation	$T_A = 25^\circ\text{C}$ , $10\text{mA} < I_{out} < I_{max}$ $V_{out} < 5\text{V}$ , (Note 2) $V_{out} > 5\text{V}$ , (Note 2)		5	15		5	25	mV
			0.1	0.3		0.1	0.5	%
			50	100		50	100	$\mu\text{A}$
Adjustment Pin Current			0.2	5		0.2	5	$\mu\text{A}$
Adjustment Pin Current Change	$10\text{mA} < I_L < I_{max}$ $2.5\text{V} < (V_{in} - V_{out}) < 40\text{V}$							
Reference Voltage	$3 < (V_{in} - V_{out}) < 40\text{V}$ , (Note 3) $10\text{mA} < I_{out} < I_{max}$ , $P < P_{max}$ $3\text{V} < V_{in} - V_{out} < 40\text{V}$ , (Note 2)	1.20	1.25	1.30	1.20	1.25	1.30	V
Line Regulation	$10\text{mA} < I_{out} < I_{max}$ , (Note 2)		0.02	0.05		0.02	0.07	%/V
Load Regulation	$V_{out} < 5\text{V}$ $V_{out} > 5\text{V}$		20	50		20	70	mV
			0.3	1		0.3	1.5	%
			1	5		1	10	mA
Temperature Stability	$T_{min} < T_j < T_{max}$ $V_{in} - V_{out} = 40\text{V}$ $V_{in} - V_{out} < 15\text{V}$		1.5	2.2		1.5	2.2	A
Minimum Load Current	K Package		0.5	0.8		0.5	0.8	A
		H Package		0.4	0.7		0.4	0.7
Current Limit	$V_{in} - V_{out} = 40\text{V}$ K Package H Package		0.4	0.7		0.4	0.7	A
		H Package		0.07	0.07		0.07	0.07
RMS Output Noise, % of $V_{out}$	$T_A = 25^\circ\text{C}$ , $10\text{Hz} < f < 10\text{kHz}$		0.003			0.003		%
Ripple Rejection Ratio	$V_{out} = 10\text{V}$ , $f = 120\text{Hz}$ $C_{adj} = 10\mu\text{F}$ $T_A = 125^\circ\text{C}$		65			65		dB
			80		66	80		dB
			0.3	1		0.3	1	%
Long-Term Stability								%
Thermal Resistance, Junction to Case	H Package		12	15		12	15	$^\circ\text{C}/\text{W}$
		K Package		2.3	3		2.3	3

Note 1: Unless otherwise specified these specifications apply  $-55^\circ\text{C} < T_j < +150^\circ\text{C}$  for the LM117,  $-25^\circ\text{C} < T_j < +150^\circ\text{C}$  for the LM217 and  $0^\circ\text{C} < T_j < +125^\circ\text{C}$  for the LM317;  $V_{in} - V_{out} = 5\text{V}$  and  $I_{out} = 0.1\text{A}$  for the TO-5 package and  $I_{out} = 0.5\text{A}$  for the TO-18 package and TO-220 package. Although power dissipation is internally limited, these specifications are applicable for power dissipations of 2W for the TO-5 and 20W for the TO-3 and TO-220.  $I_{max}$  is 1.5A for the TO-3 and TO-220 package and 0.5A for the TO-5 package.

Note 2: Regulation is measured at constant junction temperature. Changes in output voltage due to heating effects must be taken into account separately. Pulse testing with low duty cycle is used.

Note 3: Selected devices with close tolerance reference voltage available.



Figure 3. Decoupling capacitors can be added to improve the ripple and line transient rejection of the LM317, but protection diodes are needed to prevent them discharging into the IC under fault conditions.

Figure 4. Ripple rejection versus output voltage with (A) and without (B) C2.

Figure 5. Line interference rejection versus frequency (A) with C2, (B) without C2.

Figure 6. Response to line transient with (dotted) and without (bold) decoupling capacitors.

Figure 7. Remote shutdown of the regulator using an NPN transistor.

Figure 8. Slow-rise power supply.

Figure 9. Using the LM317 as a current source.

Figure 10. A practical power supply design using the LM317.

Photo 1. A laboratory power supply using the LM317.

Photo 2. The circuit board of figure 11 used as an equipment power supply with the p.c. board mounted on the back of the heatsink.

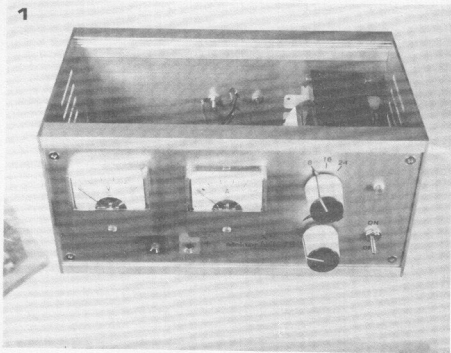
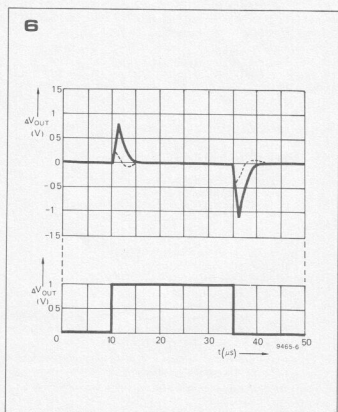
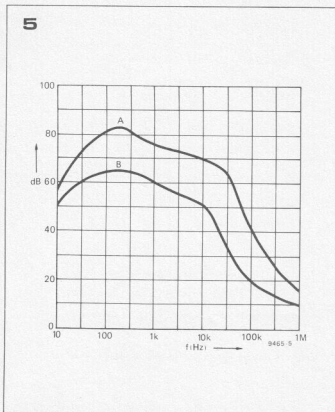
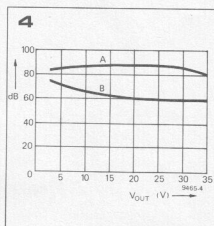
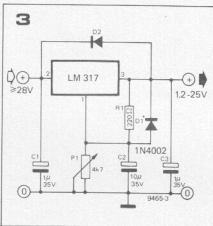

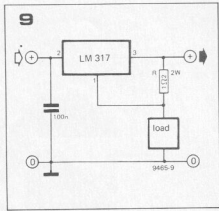
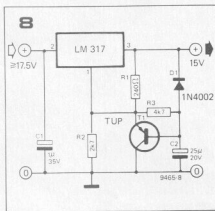
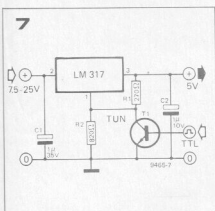
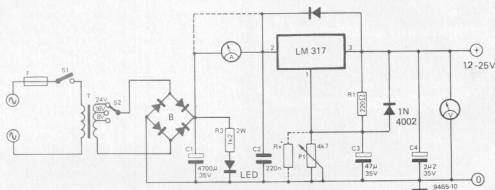
**10**

\* see text

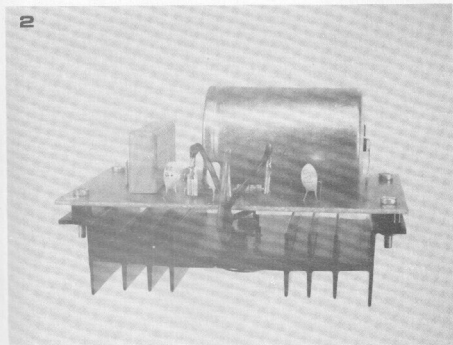

connected between pins 3 and 5 then a current  $\frac{V_{ref}}{R}$  flows through it. If a load is connected between pin 1 and ground then (neglecting the leakage current from pin 1) the same current must flow through the load. This configuration is shown in figure 9.

### A practical power supply

The circuit of a practical power supply suitable for use in equipment or as a laboratory supply is given in figure 10. This will provide voltages from 1.2-25V. It is possible to vary the output voltage continuously over this range using a single input voltage of 36V, but at low

output voltages most of this would be dropped across the IC, and if large currents were being drawn the internal power limiting circuits of the IC could operate, shutting down the circuit. For this reason a transformer with three secondary taps is used, for maximum output voltages of approximately 8, 15 and 25 volts respectively. With P1 at its maximum setting Rx is varied to set the maximum output voltage to 25 V. It is important to realise that, while P1 varies the output voltage over the entire range 1.2 to 25 V S2 must be set to the appropriate position for the desired output voltage. For example, it is no use having P1 turned to the 25 V setting with S2 in the 8 V position. The IC will simply cease to regulate and a large amount of ripple will appear at the output. For fixed voltage applications Rx may be replaced by a resistor and P1 may be omitted.

It may seem strange that the ammeter to monitor the output current is shown connected on the input side of the circuit, since it will register the current through R1 and R2 even when the output current is zero. However, this current is less than 1% of full scale current, so it will hardly be noticeable on the meter, and placing the ammeter on the input side means that its resistance does not increase the output impedance of the supply, which would spoil the regulation.

11

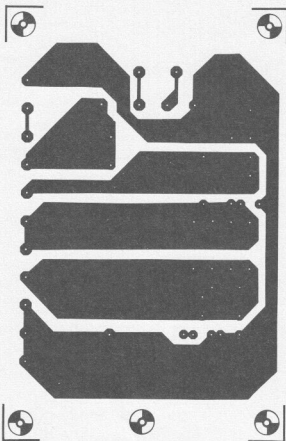

12

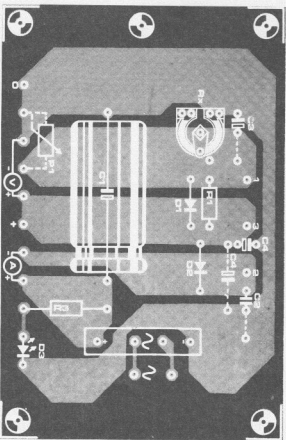

## Parts list for figure 10

## Resistors:

R1 = 220  $\Omega$   
 R3 = 1 k $\Omega$   
 Rx = 10 k preset or fixed resistor.  
 See text.  
 P1 = 4k7 or 5 k lin potentiometer.

## Capacitors:

C1 = 4700  $\mu$  35 V  
 C2 = 220 n  
 C3 = 47  $\mu$  35 V  
 C4 = 2 $\mu$ 2 35 V

## Semiconductors:

D1, D2 = 1N4002  
 D3 = LED  
 IC = LM317K  
 B = Bridge rectifier 40 V 2.2 A.

## Miscellaneous:

T = transformer with 0.8-16-24 V  
 2A secondary.  
 S1 = SPST 250 V 1A switch  
 S2 = single-pole three-way switch  
 F = 250 mA slow blow fuse.  
 Ammeter 0-2A  
 Voltmeter 0-25V

Figures 11 and 12. Printed circuit board and component layout for the IC power supply (EPS 9465).

## Construction

A printed circuit board and component layout for the IC power supply are shown in figures 11 and 12. Photograph 1 shows the front panel of one of these units built as a laboratory power supply, while photograph 2 shows a version for use in a piece of equipment. The p.c. board is mounted direct on the back of the heatsink and the ammeter and voltmeter are dispensed with in this instance. **M**

# MINI-PHASE

R. Otterwell

The mini phase is a low-cost, simple but effective phasing unit for the musician. It incorporates a preamplifier to enable it to be used with a wide variety of inputs such as guitar, microphone, electronic organ and synthesiser.

The preamplifier consists of T1 and its associated components. Since no gain can be provided by the phase shift circuits this provides the only gain in the unit. P1 acts as a gain control and if this control is advanced then (depending on the input signal level) clipping may occur. This increases the harmonic content of the input signal and enhances the phasing effect, which can be desirable on occasion.

At the output from P1 the signal is split. A portion is fed direct to P3 and a portion to P3 via the phase shifter. The phase shifter comprises two phase splitters T2 and T3. These have equal emitter and collector resistors so that the signals appearing at the emitter and collector have the same amplitude but are inverted with respect to one another. The phase of the signal at the junction of C4/P2A and C6/P2B may be varied by adjusting P1. Each stage can intro-

duce a phase shift from a few degrees to almost  $180^\circ$ , or  $360^\circ$  in all.

T4 is connected as an emitter follower, providing a high input impedance to buffer the output of the second phase-shift network, and a low output impedance. The signal is fed from the emitter of T4, via C7, to one end of P3. The direct (non-phase-shifted) signal is fed to the other end. P3 acts as a

'balance' control between these two signals, and varying P3 alters the proportion of direct to phase-shifted signal. P3 may be adjusted so that, when  $180^\circ$  phase-shift occurs, the direct and phase-shifted signals cancel each other.

## Construction

If the unit is to be used with a portable instrument such as a guitar or small synthesiser then it is probably best to mount it in a small box with a 'swell pedal' arrangement, linked to P2, on top. If used with a larger instrument such as an organ then it could possibly be built in. The current consumption of the unit is only a few milliamps and can be supplied by a PP3 or PP6 battery. Alternatively power may be derived from the other equipment with which it is used.

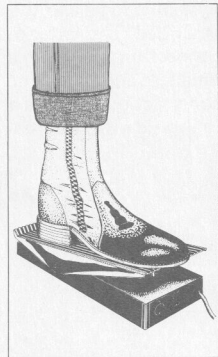
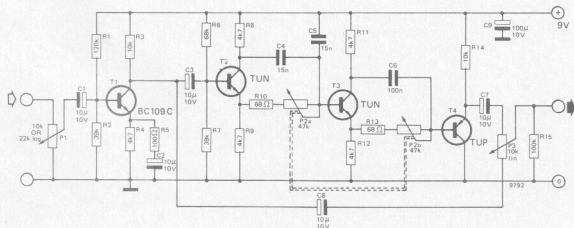

Figure 1. Circuit of the Mini-Phase.







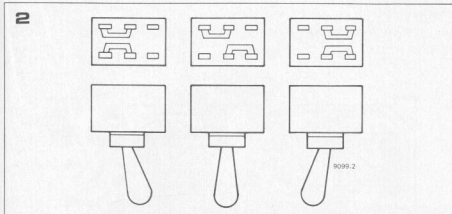
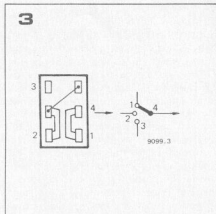

Figure 1. Circuit of channel switching logic.

Figures 2 and 3. Showing the contact configuration (figure 2) and wiring to (figure 3) S2, S4, S6 and S7.

Photo 1. Completed motherboard.



### Y1 only mode

The channel mode is controlled by S6. With S3 in the 'normal' position and S6 in the 'Y1' position IC7 is held in the 'preset' condition with the Q output high and the Q output low. The output of N4 (output I) is low and output II is high, so T9 in the Y1 preamp is turned off and T8 is turned on routing the Y

and  $\bar{Y}$  outputs through to the Y amplifier but blocking them from the X amplifier. Output III is low, so T7 is turned off and the timebase outputs are switched through to the X amplifier. The outputs of both N5 and N6 (IV and V) are high, so T8 and T9 in the Y2 preamp are turned on, blocking the outputs of this preamp.

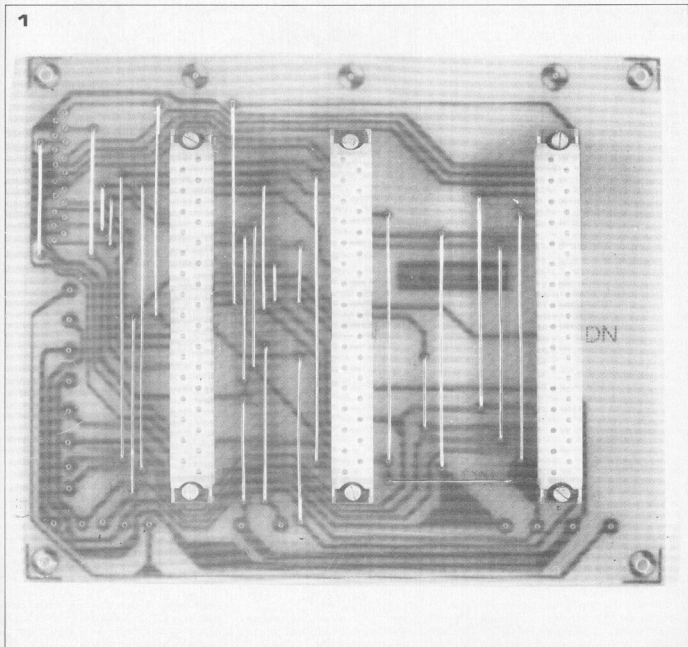

### Y2 only mode

With S6 in the 'Y2' position IC7 is held in the 'clear' state with the Q output high and the Q output low. Outputs I and II are high, so the outputs of the Y1 preamp are blocked. Depending on the position of the norm/invert switch either output IV or output V will be low. In the 'norm' position output V is low and output IV is high, T9 in the Y2 preamp will be turned off and T8 will be turned on, so the outputs of the Y2 preamp will be switched to the Y amplifier in the correct sense (i.e. so that a positive input voltage deflects the trace upwards). With S6 in the 'invert' position T8 is turned off and T9 is turned on, so the Y2 outputs are switched to the Y amplifier in an inverted sense.

### Y1/Y2 mode

With the channel switch S6 in the 'Y1/Y2' mode the preset and clear inputs are both high so the flip-flop may be clocked by pulses from N2. On each change of state of the outputs of IC7 the inputs of the Y amplifier are switched between the Y1 and Y2 preamp outputs. Again, Y1 may be in either the normal or inverted mode.

### X-Y mode

Finally, with S3 in the 'X-Y' position IC7 is held in the clear condition via D9. Output I is high while output II is low, so T8 in the Y1 preamp is turned off and T9 turned on. The outputs from the Y1 preamp to the Y amplifier are blocked and its outputs are switched to the X amplifier inputs.

Pin 2 of N3 is also low, so its output is high and blanking pulses are inhibited. Output III is high, turning on T7 and blocking the outputs of the timebase.

The timebase, trigger circuit and channel switching logic are all mounted on a single printed circuit board, which is shown in figure 4. Because of the limited space available on the plug-in module front panel, the only controls mounted on the timebase panel are the timebase range switch, X-position and trigger level controls. The trigger polarity, trigger select, trigger mode, X-Y and X expansion switches are all mounted on a subsidiary panel, which forms part of the CRT fascia. These switches are wired direct to the motherboard. This arrangement also makes for more logical grouping of control functions.

### The motherboard

Connections to the timebase and Y preamp boards are made by Euro-standard edge connectors and wiring between these boards is greatly simplified by the use of a printed circuit backplane or 'motherboard'. This is shown in figures 5 and 6, and looking at figure 6, it will be seen that the connections to this board are arranged further to simplify the wiring of the oscilloscope. At the top left-hand corner are the connections to all the display mode controls. These points may be con-

4a

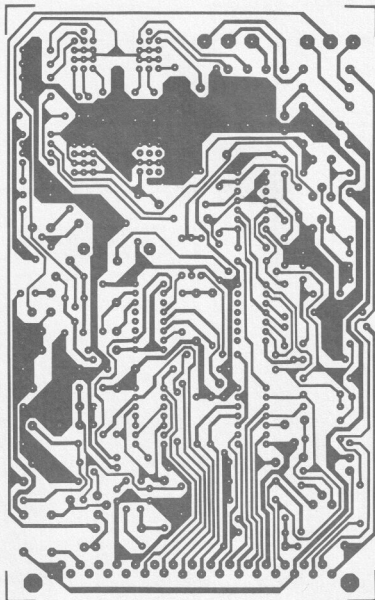

ted direct to the controls on the front panel by using ribbon cable. Below this are the supply connections and outputs to the X and Y amplifiers, and if the CRT is mounted to the left of the motherboard the connections between these boards can be very short. At the bottom left-hand corner of the motherboard are the supply connections and blanking output to the high-voltage p.e. board. The front panel for this forms part of the CRT fascia for the 7 cm tube, but is a separate panel for the larger tubes.

Finally, at the bottom right-hand corner of the motherboard are the connections from the power supply printed circuit.

### Construction

Assembly of the various printed circuit boards should present few difficulties, the only point to watch being the precautions to be taken to avoid components shorting to the earth plane on the Y preamp boards. A complete diagram of the interwiring between the various boards is given in figure 7. It should be noted that connections to the CRT base will vary depending on the type of tube used, and the connections to the high-voltage circuit board, the X and Y amp and the 6.3 V heater supply should be made with reference to the tube pin configurations given in

4b

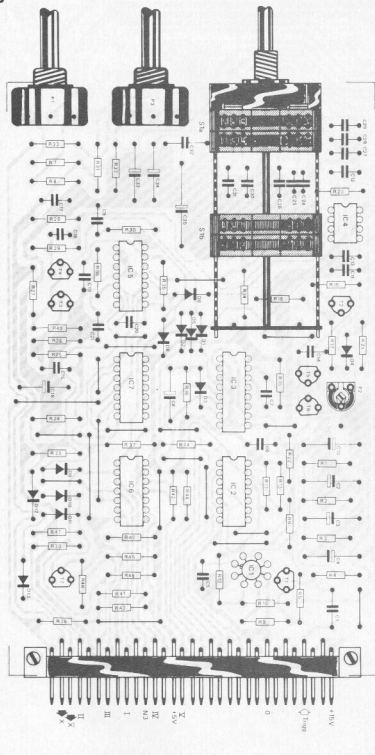

Figure 4. Printed circuit board and component layout for the timebase module, which also contains the channel-switching logic and trigger circuits.

part 1 of the article. All connections to the tube operating at high voltages (this includes the heater supply) should be made with adequately insulated wire. All interconnections between boards may be made with ribbon cable, which gives a very neat appearance. Note that when using a 7 cm tube the mains on/off switch is mounted on the intensity control because of space considerations, though some alternative position may be found for it at the constructor's discretion. In the case of the larger tubes provision is made for a separate on/off switch on the CRT control panel. Note that the x5 expansion control may be either a toggle switch with a preset

## Parts list for timebase module

## Resistors:

R1, R31, R32 = 100  $\Omega$   
 R2, R4, R15, R16, R20, R25,  
 R26, R27, R47 = 10 k  
 R3 = 1k5  
 R5, R36, R39, R46 = 4k7  
 R6, R7, R9, R13, R14, R19, R22,  
 R23, R30, R33, R34, R37, R38,  
 R40 . . . R45, R48 = 1 k  
 R8 = 1k8  
 R10 = 820  $\Omega$   
 R11, R24, R29 = 2k2  
 R12 = 1 M  
 R17 = 33 k  
 R18 = 100 k  
 R21 = 27  $\Omega$   
 R28 = 6k8  
 R35 = 330  $\Omega$   
 R49 = 3k9  
 P1, P3 = 1 k, lin.  
 P2 = 22 k preset

## Capacitors:

C1, C32 = 1  $\mu$  (polycarbonate)  
 C2, C3, C4, C10, C18,  
 C34 = 10  $\mu$ /16 V (preferably tantalum)  
 C5, C6, C9, C13, C17, C30 = 100 n  
 C7 = 6p8  
 C8 = 4 $\mu$ /16 V (preferably tantalum)  
 C11 = 220 n  
 C12, C28 = 10 n  
 C14 = 33 p  
 C15 = 120 p  
 C16, C21 = 330 p  
 C19 = 15 n  
 C20, C26 = 1 n  
 C22, C23 = omitted  
 C24 = 120 p  
 C25 = 270 p  
 C27 = 3n3  
 C29 = 33 n  
 C31 = 330 n  
 C33 = 3 $\mu$ /16 V  
 C35 = 33  $\mu$ /16 V

## Semiconductors:

IC1 = LM 311  
 IC2, IC6 = 7400  
 IC3 = 74123  
 IC4 = 555  
 IC5 = 7413  
 IC7 = 7474  
 T1, T3, T4, T6, T7 = BC 547 B  
 T2, T5 = BC 557 B  
 D1 . . . D5, D8, D10 . . . D13 = 1N4148  
 D6, D9 = AA 119 (Germanium-Diode)  
 D7 = omitted

## Miscellaneous:

S1 = 'Seuffer' 2-pole 12-way  
 p.c. mounting switch  
 31-way Euro-standard, edge  
 connector plug and socket

p.c. board EPS-9099-1 -  
 see part 3 figure 4  
 front panel trim EPS 9361-2 -  
 see part 3 figure 10

5

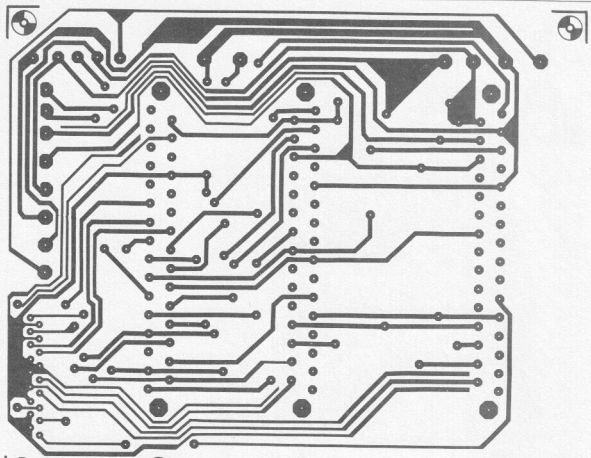

6

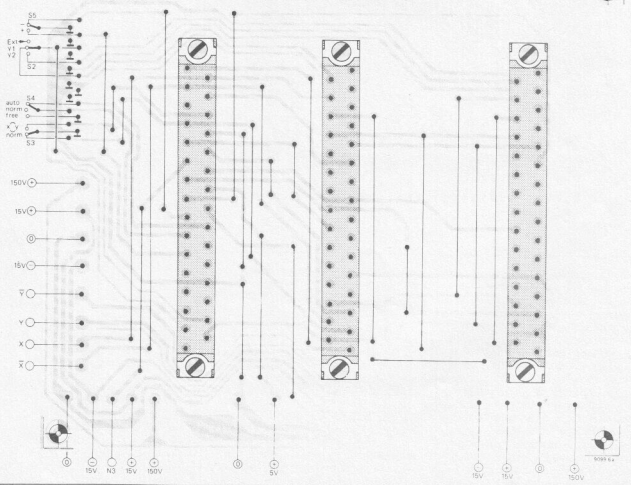

## Parts list for Y preamp module.

Resistors:  
 R1, R3, R5, R7 = 1 M  
 R2 = 330  $\Omega$   
 R4 = 1 k  
 R6 = 3k3  
 R8 = 10 k  
 R9, R16 = 680 k  
 R10 = 270 k  
 R11 = 33 k  
 R12 = 820 k  
 R13 = 82 k  
 R14 = 100 k  
 R15 = 12 k  
 R17 = 470 k  
 R18 = 1 M  
 R19 = 100 k  
 R20, R23, R24 = 100  $\Omega$   
 R21, R22, R32, R33, R34 = 4k7  
 R25, R27 = 270  $\Omega$   
 R26 = 22  $\Omega$   
 R28, R31 = 1k5  
 R29, R30 = 2k2  
 R35, R36 = 220  $\Omega$   
 R37 ... R40 = 1k8  
 P1 = 220  $\Omega$  lin pot.  
 P2 = 100  $\Omega$  lin pot.  
 P3 = 220  $\Omega$ , preset  
 P4 = see text

Capacitors:  
 C1, C3, C5, C7, C9 = trimmer 10 ... 40 p  
 C2 = 100 n  
 C4 = 33 n  
 C6 = 10 n  
 C8 = 3n3  
 C10 = 1 n  
 C11, C13 = trimmer 10 ... 60 p  
 C12 = 330 p  
 C14 = 33 p  
 C15 = 100 n/250 V  
 C16 = 10 n  
 C17, C18, C24, C28 = 100 n  
 C19, C23, C25, C26 = 10  $\mu$ /16 V  
 preferably tantalum  
 C20, C22 = 47 p These need be added  
 only if instability occurs.  
 C21 = see text

Semiconductors:  
 T1, T3, T8, T9 = BC 547 B  
 T2, T4, T5, T6, T7 = BC 557 B  
 T10 = E 420, E 430 or 2 x E 300  
 D1 ... D14 = 1N4148

Miscellaneous:  
 S6, see text  
 S7, single-pole three-way, see text  
 S9, 'Seuffer' p.c. mounting 2-pole  
 12 way switch  
 31-way Euro-standard edge connector  
 plug and socket

p.c. board EPS 9099-2 —  
 see part 2 figure 12  
 front panel trim EPS 9361-3 or 9361-4  
 see part 3 figure 10

Figure 5. Track pattern of the motherboard.

Figure 6. Component layout of the motherboard.

## Complete parts list for boards shown in parts 1 and 2.

## Parts list for X and Y output amplifier.

Resistors:  
 R1, R11, R15, R25 = 100  $\Omega$   
 R2, R10, R14, R16, R24 = 1 k  
 R3, R4, R7, R8, R17, R18,  
 R21, R22 = 10 k/1 watt  
 R5, R9, R19, R23 = 680  $\Omega$   
 R6, R20 = 82  $\Omega$   
 R12 = 330  $\Omega$   
 R13 = 3k9  
 P1, P2 = 2k2 (preset)  
 P3 = 220  $\Omega$  (preset)

Capacitors:  
 C1 = 220 n  
 C2 = 100 n/250 V  
 C3, C4 = 10  $\mu$ /16 V  
 C5 = 100 n

Semiconductors:  
 T1, T2, T6, T7 = BF 458  
 T3 ... T5, T8 ... T10 = BC 140, BC 141  
 D1 ... D4 = 1N4148

Miscellaneous:  
 CRT socket  
 Heatsinks for T1, T2, T5, T6, T7 and T10

p.c. board EPS 9099-5 —  
 see part 2 figure 7

## Parts list for power supply board

Resistors:  
 R1, R2 = 82  $\Omega$   
 R3, R4 = 2,7  $\Omega$   
 R5, R7, R8 = 3k9  
 R6 = 1 k  
 R9 = 150 k  
 R10 = 18 k  
 R11 = 10  $\Omega$

Capacitors:  
 C1, C2 = 470  $\mu$ /25 V  
 C3, C4, C13 = 10  $\mu$ /6,3 V tantalum  
 C5, C6 = 22 n  
 C7, C10, C12 = 10  $\mu$ /16 V tantalum  
 C8, C9 = 1  $\mu$   
 C11 = 470  $\mu$ /16 V  
 C14, C17 = 100 n  
 C15 = 470 p  
 C16 = 16  $\mu$ /250 V  
 C18 = 47  $\mu$ /250 V

Semiconductors:  
 D1 = 33 ... 39 V zener 1 W  
 D2, D3, D4, D5 = 1N4004  
 B1, B2 = B40C500  
 T1 = BD 136, BC 430  
 T2 = BD 135, BC 429  
 T3 = BD 232, BF 458  
 IC1 = 3501 TO or DIL package  
 IC2 = L 129, 7805  
 IC3 = 723 DIL-package

Miscellaneous:  
 Heatsinks for IC1, IC2, T1, T2, T3.  
 Special Elektroskope mains transformer.

p.c. board EPS 9099-3 —  
 see part 1 figure 4

## Parts list for 1000 V high voltage module

Resistors:  
 R1 = 47 k  
 R2 = 100 k  
 R3, R4, R5 = 1 M5  
 R6 = 470 k  
 R7 = 1 M5 or 470 k  
 R8 = 10 k  
 R10, R11 = 3k9  
 R12 = 1k8  
 R13 = 5k6  
 R14 = 1 k  
 R15, R16 = 47  $\Omega$   
 P1 = 100 k lin  
 P2 = 1 M lin  
 P3 = 220 k preset  
 P4 = 220 k lin pot. with mains switch

Capacitors:  
 C1, C2, C3 = 100 n/1000 V  
 C4 = 100 n/1000 V  
 C6 = 10 p  
 C7 = 220 p  
 C8, C9 = 220 n

Semiconductors:  
 T1 = BC 547 B  
 T2 = BC 557 B  
 D1 = 1N4148, 1N914  
 D2 = BY 187, BY 209 or other  
 2kV diode  
 D4, D5 = AA 119 or other  
 germanium diode

Miscellaneous:  
 p.c. board EPS 9099-4 —  
 see part 1 figure 12

## Parts list for 2000 V high voltage module

Resistors:  
 R1 = 47 k  
 R2 = 100 k  
 R3, R4, R5, R7 = 1 M5  
 R6 = 1 M  
 R8, R9 = 10 k  
 R10, R11 = 3k9  
 R12 = 1k8  
 R13 = 5k6  
 R14 = 1 k  
 R15, R16 = 47  $\Omega$   
 R17 ... R20 = 22 M/5 W  
 P1 = 100 k, lin.  
 P2 = 1 M, lin.  
 P3 = 220 k, preset  
 P4 = 220 k, lin. pot.

Capacitors:  
 C2a, C2b, C3a, C3b = 220 n/1000 V  
 C4, C5 = 100 n/1000 V  
 C6 = 10 p  
 C7 = 220 p  
 C8, C9 = 220 n

Semiconductors:  
 T1 = BC 547 B  
 T2 = BC 557 B  
 D1 = 1N4148, 1N914  
 D2, D3 = BY 187, BY 209 or  
 other 2kV diode  
 D4, D5 = AA 119 or other germanium  
 diode

Miscellaneous:  
 p.c. board EPS 9099-7 —  
 see part 1 figure 11  
 front panel trim EPS 9410-2 —  
 see part 3 figure 11



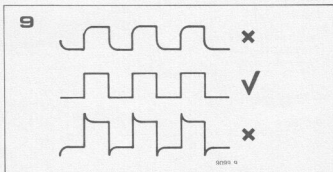
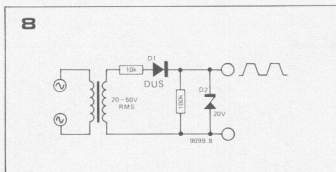
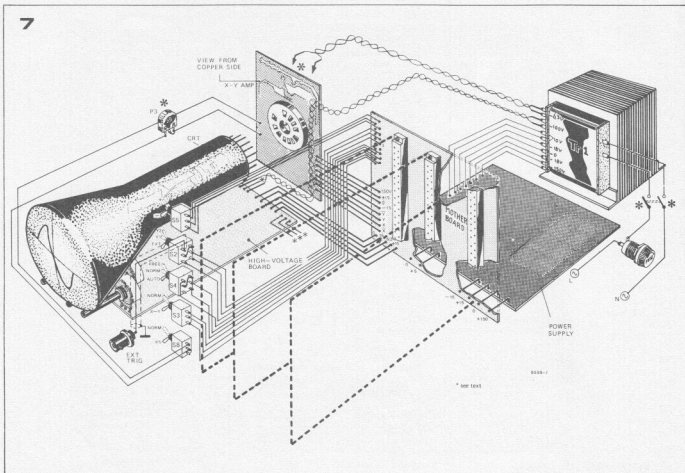

Figure 7. Exploded wiring diagram of the Elektroscope.

Figure 8. Calibration circuit for the timebase and deflection amplifiers.

Figure 9. Showing the correct and incorrect waveforms when setting up the Y attenuator.

Figure 10. Front panel layout for the 7 cm version of the Elektroscope.

Figure 11. Fascia for the 13 cm CRT.

Figure 12. Front panel for the 2000 V supply.

Figure 13. Rectangular mask for the 13 cm CRT.

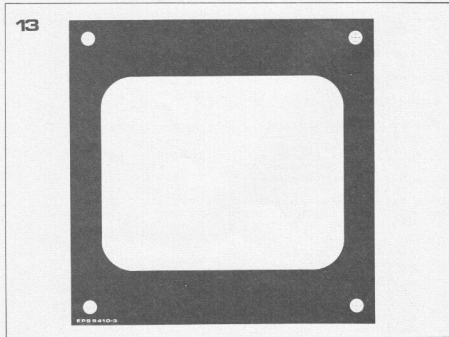

potentiometer mounted behind it, or if fine control of X expansion is required this may be replaced by a miniature potentiometer with on/off switch.

No mechanical details of the construction are given since it is felt that constructors will wish to adopt their own style, and it is anticipated that some suppliers will make cases available for the less constructionally adept. Appearance parts always present a problem, however, so to give a professional finish a set of front panel trim will be available from the EPS service.

To assist the constructor a series of photographs is given showing various constructional points and the general layout of the oscilloscope, which should be adhered to.

## Do's and Don'ts

### DON'T

- knock, bend, file or saw the mumetal CRT screen, as this will destroy its magnetic properties.
- use the output amplifier/CRT base assembly as a support for the back end of the CRT. The CRT should be supported at the front by a (non-magnetic) ring or other clamp, and by a clamp about halfway down the neck. The CRT base should float freely on the tube pins and should not be used as a support for the output amplifier board, which should be mounted independently on the main chassis.
- All clamps and mountings on the CRT, and the inside of the mumetal screen, must be cushioned by foam draught excluder or something similar.

### DO

- Check and double check the wiring and p.c. boards for mistakes, dry joints etc, before switching on any power. A little care at this stage will save a great deal of expense later.
- test the power supply circuits before

11

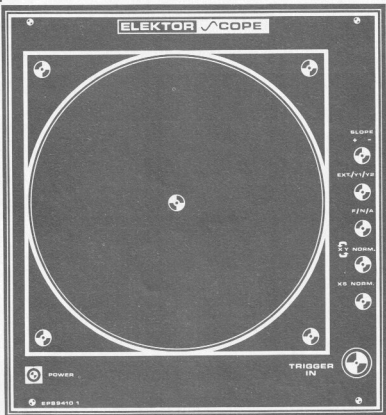

12



10

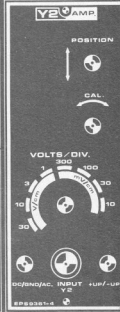
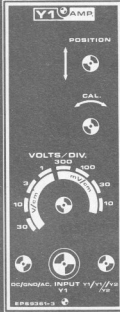
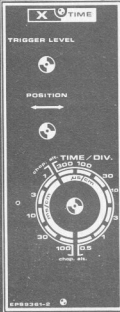
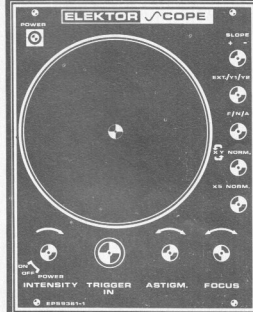

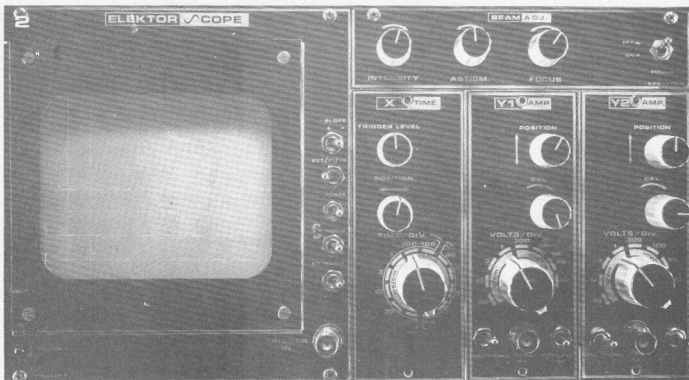

connecting to any other part of the circuit. This is dealt with under 'Testing and Calibration'.

## Testing and calibration

### 1. Power supply

The power supply should be tested before connecting its outputs to the motherboard, and to do this satisfactorily the voltages should be measured both on and off load. Dummy loads should be made up from resistors or combinations of resistors to the following values.

5 V supply — 27  $\Omega$  1 W  
 15 V supplies — 82  $\Omega$  2.5 W  
 150 V supply — 3k $\Omega$  7.5 W

The off load voltage of the 150 V supply may be considerably higher than 150 V, but should drop to 150 V on load. Note that although this supply is current limited it is not short-circuit proof, so care should be taken not to short its outputs.

The EHT supply on the high-voltage circuit board should also be tested. If the multimeter used does not have a high enough range then its range can be extended by the use of series resistors. Three or more equal resistors in series should be used so that only a portion of the EHT voltage is dropped across each and their voltage ratings are thus not exceeded. The required resistor value is given by:

$$R = (V_1 - V_2) \cdot x$$

where R is the series resistance

V<sub>1</sub> is the required voltage range

V<sub>2</sub> is the actual meter range

x is the 'ohms per volt' of the meter.

It is obviously best to make the extended meter range a convenient multiple of one of the ranges on the meter, for example:

if the meter is 20,000  $\Omega$ /V and has a

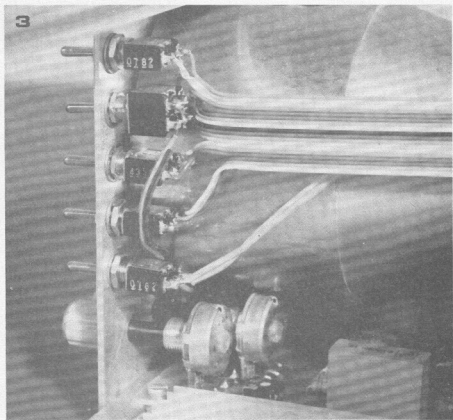

300 V range then this can be converted to a 3000 V range. The required series resistance is  $(3000 - 300) \times 20,000 = 54 \text{ M}\Omega$ . Naturally great care should be taken when measuring the EHT voltage.

### 2. Mainframe

Having tested the power supplies and connected them to the rest of the circuit, the mainframe of the oscilloscope can be tested. The Y preamps and timebase should not be plugged in at this point. P3 on the CRT circuit board should be turned fully clockwise, and the intensity control should be turned

Photo 2. Showing front panel layout of the two versions of the Elektroscope.

Photo 3. Wiring to the switches on the CRT fascia.

Photo 4. Showing wiring to the X and Y amplifier and CRT base.

Photo 5. View of the oscilloscope with the timebase and Y modules removed, showing motherboard and wiring to CRT base.

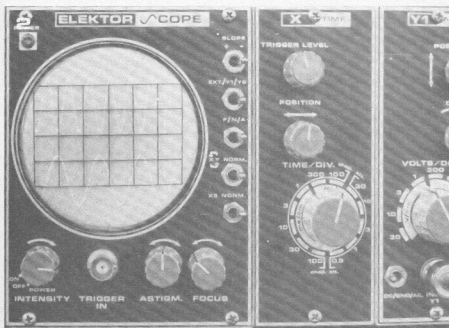

fully anticlockwise before applying power. The focus and astigmatism controls should be left in the mid-position. As soon as the CRT heaters are warmed up the intensity control may be turned fully clockwise and P3 turned until a spot or patch of light appears on the screen. This may be adjusted with the focus and astigmatism controls until it is a small circular dot. P3 may now be rotated further until the spot may be viewed comfortably in normal ambient light, but should not be rotated so far that a pronounced 'halo' appears round the spot, since operation under these conditions may cause a permanent burn on the CRT phosphor. When adjusting P3 it will be necessary to alter the astigmatism and focus controls to maintain the size and shape of the spot.

### 3. Timebase

Having checked the CRT circuit the timebase module may now be tested. Plug the timebase module into the correct position in the motherboard, switch on the power and set S4 to 'auto' and S3 to 'normal'. A horizontal line should now appear on the screen, and it should be possible to shift its position with the 'position' control.

By adjusting P2 on the output amplifier board it should be possible to vary the length of the line, but with the larger CRT's it may not be possible to make the line extend over the entire screen width. Provided the X deflection amplifier is working correctly this is due to low sensitivity of the CRT. If this is the case the X deflection amplifier will 'run out of steam' and clip, and this can be seen by the fact that the trace is brighter at the ends than in the middle. The cure is very simple. With P2 at minimum reduce the final anode voltage by increasing R6 on the high-voltage board until it is possible to obtain a trace over slightly more than the useful screen width (if the CRT is imagined as having a rectangular mask then the useful screen width of the 13 cm tube is about 10 cm, so make the trace about 11 cm long). Having adjusted the final anode voltage if necessary, increase the value of P2 until the trace just occupies the useful screen width and is uniform in brightness. If S8 is now switched to the x5 position and P3 set to minimum the trace should again exceed the useful screen width and will be brighter at the ends than in the middle. The X amplifier will always clip with S8 in the x5 position since we are trying to amplify the timebase output to more than the maximum voltage swing of the X amplifier. However this does not matter provided the central expanded portion of the trace is linear, and the brighter ends will be off the edges of the screen anyway.

It may be found as the timebase switch is rotated that the length of the trace will change. This is not a fault but is due to limitation inherent in the timebase design. It should cause no inconvenience in practice.

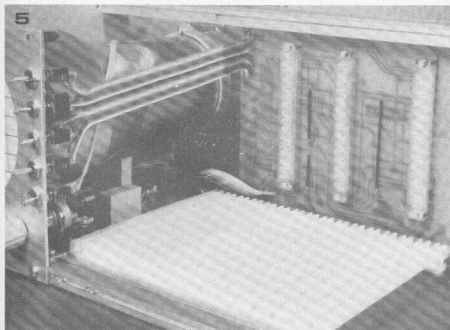
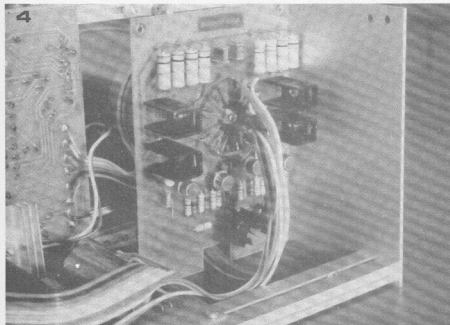

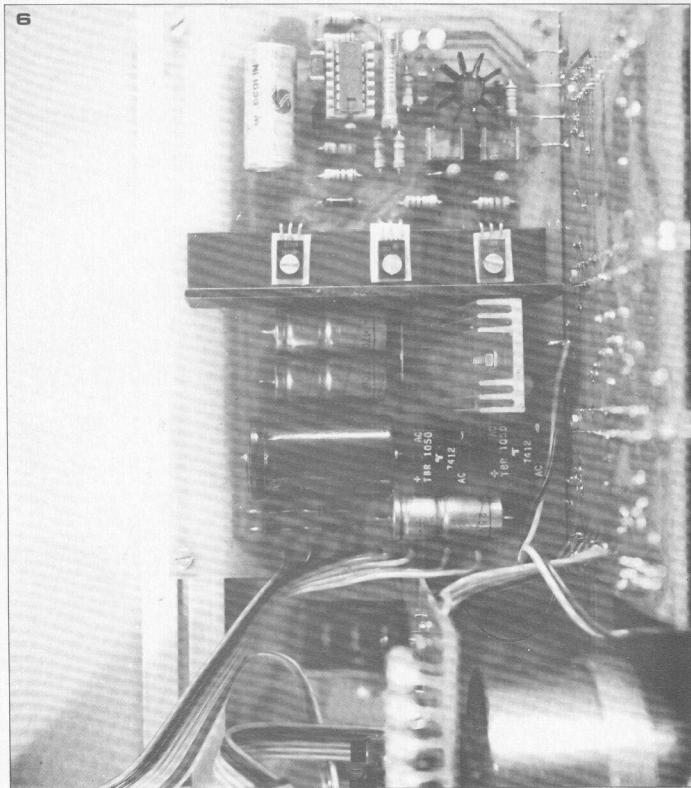

Having checked that the timebase functions on all ranges the Y preamps must be tested before the timebase can be calibrated.

### Y preamps

Plug the Y preamp modules into their correct positions and set the attenuator controls to the 30 V/cm position. Set the Y1/Y2 switch S6 to the Y1/Y2 position, and by adjusting the position controls it should be possible to obtain two horizontal lines on the screen. Check that with S6 in the Y1 or Y2 position the appropriate trace appears on the screen. The timebase speed may

now be set by feeding a squarewave of known frequency into one of the Y inputs, remembering to set the sync selection switch to either Y1 or Y2 as appropriate. A suitable circuit for calibrating the timebase and Y amplifiers is given in figure 8.

With the timebase switch set to the 3 ms/cm position P2 on the timebase module can now be adjusted so that one cycle of the 50 Hz waveform occupies  $6\frac{2}{3}$  divisions of the graticule. All the other timebase speeds should now be correct to within the tolerance allowed by the timing capacitors. On the 10 ms, 30 ms and 100 ms speeds

Photo 6. The power supply is mounted behind the motherboard.

Photo 7. Showing the assembly of the p.c. mounting switches used in the timebase and Y preamps.

Figure 14. Assembly of the 2-pole 12-way switches.



7

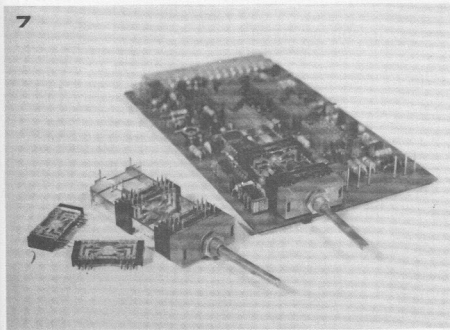

the calibration accuracy may be poor due to the high tolerances of the electrolytic capacitors used. Some slight non-linearity of the timebase may also be noticed on these ranges due to the polarizing voltage of the capacitors. The perfectionist can, of course, correct the speeds by padding the capacitors to obtain the exact value, but it is probably not worth the effort at such low timebase speeds, since these are rarely used for time or frequency measurements.

Having calibrated the timebase speeds the x5 expansion switch can be adjusted. With S8 in the x5 position P3 is simply adjusted until one cycle of the waveform occupies 5 times the length that it does on the normal position.

Since the gain of the X amplifier is now fixed the gain of the Y1 preamp must be adjusted to give the correct deflection in the X-Y mode. S3 is set to the X-Y position and the calibration signal is fed into the Y1 input. With P1 in the 'cal' position and S9 set to 10V/cm P2 on the Y1 preamp module is adjusted to give a trace length of 2 cm. S3 is now switched back to the normal position and P1 on the Y output amplifier is adjusted to give the same deflection. Finally, the calibration signal is fed into the Y2 input and with P1 in the 'cal' position, P2 on the Y2 module is adjusted to give the same deflection (2 cm).

The low frequency calibration of the oscilloscope is now complete, and all that remains is to adjust the trimmers on the Y attenuators. For this a square-wave signal of about 1 kHz is required. This must have a fast risetime and a low output impedance, and to avoid degradation of the signal by capacitive loading the oscillator should be connected to the oscilloscope by a very short length of cable. The procedure is to adjust each trimmer until the display on the oscilloscope is as near to a squarewave as possible, with no overshoot nor rounding-off of the

leading edge. The correct and incorrect waveforms are given in figure 9. Of course, for this calibration procedure to work the original input waveform must be really square!

### Final constructional notes

To clarify certain points mentioned in the first two parts of this article and avoid the possibility of constructional errors the following should be noted:

1. The connections between the high-voltage board and the base of the CRT were not made sufficiently clear. These connections are as follows:

high voltage board	CRT
g1	g
g2 g4	a1 a3 (S1)
k	k
g3	a2

2. The CRT heater connections (h, h in part 1 figure 9) are shown as f, f (for filament) in part 1 figures 7 and 8. The heater connections on the CRT base are connected direct to the 6.3 V winding of the transformer. The cathode connection (k) should be linked direct to one of the heater pins on the CRT base.

3. Referring to part 2 figure 7, it should be noted that the connections shown from the X and Y outputs to the CRT base apply only to the Telefunken CRTs. For X and Y pin connections to Mullard CRTs refer to part 1 figure 9 and connect as follows:

X-Y amplifier board connection	CRT base connection
from R3,R4	Y2
from R7,R8	Y1
from R17,R18	X1
from R21,R22	X2

When these connection are correctly made a positive input voltage to the Y1 channel should cause an upward deflection of the trace, and the timebase should sweep from left to right. If the connections are wrongly made then the trace will be back-to-front and/or upside down. The cure is to reverse the Y1/Y2 and/or X1/X2 connections to the CRT base.

4. In part 1 mention was made of Z modulation. This was not, in fact, incorporated in the prototype, but a Z input can be provided by an SPDT switch at the input of the blanking amplifier to switch between the output of N3 and the Z1 input socket.

5. It may be noted that the 31-way connectors in photo 1 are apparently reversed with respect to those shown in figure 6. The reason is that the connection pins on the back of the connectors are offset from the sockets. Figure 6 shows the holes for the pins, but photo 1 shows the view on the sockets.

14

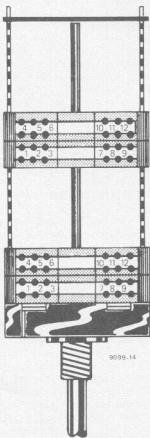

## emitter follower with current source

In its standard version an emitter follower is provided with an emitter resistor. This resistor and the base potential determine the emitter current  $I_e$  of the emitter follower. The gain of the emitter follower is always less than unity, but approaches unity as the product  $S \cdot R_e$  is greater.  $S$  is the slope, which equals  $40 \cdot I_e$ . The product  $S R_e = 40 I_e R_e$ , and thus the gain, corresponds to a certain base potential.

If  $R_e$  is replaced by a current source,  $S$  can be chosen independently of  $R_e$ . The value of  $R_e$  is then determined by the load impedance of the emitter follower which is usually much higher than the value required for the DC-setting. It is now possible to obtain a gain closely approaching unity. This is of importance for certain types of active filter. This circuit has an additional advantage. It can be shown that the distortion of an emitter follower is inversely proportional to the square of the emitter impedance  $R_e$ . As already said,  $R_e$  is much higher than usual when a current source is used. Hence distortion, too, is much less than usual. At the indicated value of  $R_e$  the emitter current is about 2 mA. Reduction of  $R_3$  involves a proportional increase in emitter current.

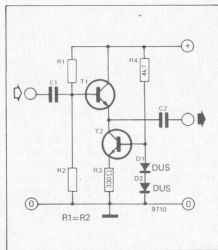

## 16 CHANNEL TAPS

Various circuits for Touch Activated Programme switches (TAPs) have previously been published in Elektor. However, these switches have had only three or four positions.

In this article are discussed two designs for TAPs having 16 positions.

The first circuit (figure 1) makes use of a diode encoder to convert into binary the hexadecimal inputs from the sixteen touch contacts. The binary code is then stored in a four-bit latch circuit, the output of which is decoded back into a one-of-sixteen format.

To make the circuit easier to follow it has not been drawn in full but has been somewhat simplified. The binary code corresponding to the input from 1 to 16 is stored in four CMOS flipflops A to D. The outputs of the flip-flops are buffered by transistors T1 to T4 and are decoded by a TTL, binary to one-of-16 decoder.

Each flip-flop has a set and reset input. The 8 inputs are connected to 8 bus lines ABCD and ABCD, which are normally pulled up by 8 10 M resistors.

Each of the 16 touch contacts is connected to the cathodes of four diodes. The anodes of the diodes are connected to four of the bus lines to set or reset the flip-flops in accordance with the binary code for the particular input. Each of the blocks shown with a diode symbol corresponds to four diodes, and each output line from a block corresponds to the four anodes, which are joined to the bus lines as indicated by a blob where the lines cross. For example, the first input is given the binary code 0000, so the  $\bar{A}$   $\bar{B}$   $\bar{C}$  and  $\bar{D}$  bus lines each have a diode connected to them from this input. At the other end of the 16th input is given the binary code 1111, so the A B C and D bus lines all have connections from this input. A complete example showing the wiring of input 13 is shown in the diagram.

The disadvantage of this circuit is that it requires a total of 64 diodes for the

encoding circuits. Figure 2 shows a circuit in which the touch contacts themselves perform part of the encoding process. The latches that accept and store the touch inputs are two, four-position TAPs similar to those used in the TAP Preamp (Elektor 3 and 4, May, June 1975).

The two TAP circuits are arranged in a four-by-four matrix. When one of the inputs 1 to 4 is selected then that output goes high and applies a positive voltage to the commoned bases of one of the rows of transistors T1 - T4, T5 - T8, T9 - T12, T13 - T16. Selecting one of the inputs A to D causes that output to go high, turning on one of the transistors T17 to T20, which grounds the commoned emitters of one of the columns of transistors T1, T5, T9, T13 etc. A transistor in the matrix T1 to T16 can be turned on only if the row and column to which it belongs are both selected. Thus, if 1 A is selected a positive voltage is applied to the base of T1 and its emitter is grounded, so it turns on.

At first sight it would appear to be necessary to touch two contacts — a row and a column input — to select a particular output. However, by arranging the touch contacts as two-pole devices they can operate both a row and column input simultaneously. For example, touching the first contact activates row 1 and column A, turning on T1. Touching the second contact activates row 1 and column B, turning on T2 and so on.

In the circuit given the output transistors are shown simply switching LEDs, but of course they could be used to drive any load up to about 100 mA. ■

1

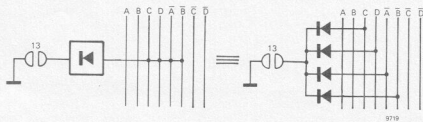
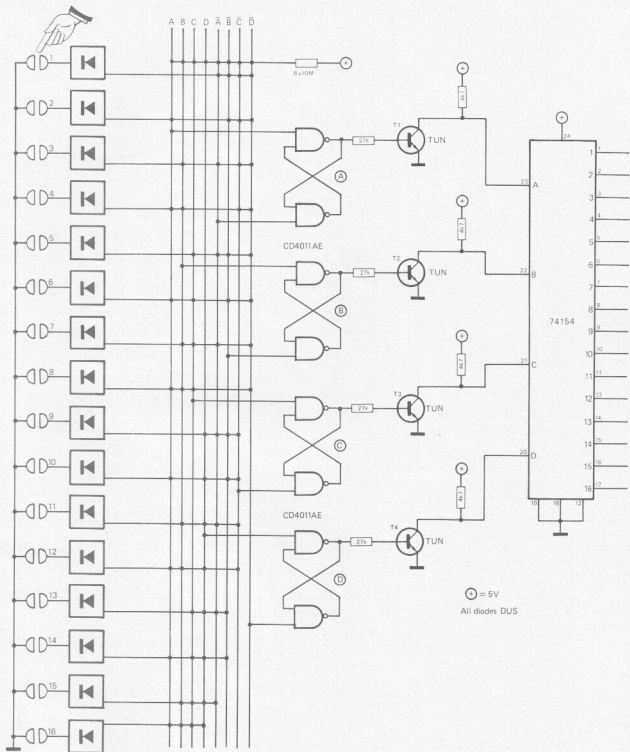

9719

1a

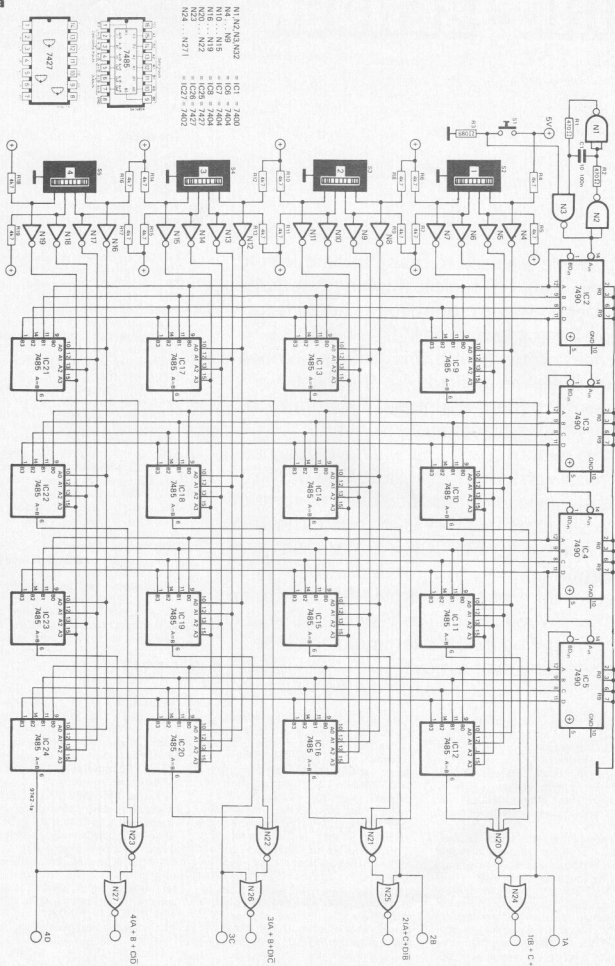
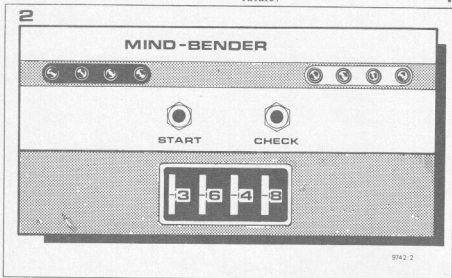





Figure 2. Suggested front panel layout for the Mind-bender.



### Final notes.

The complete circuit requires a total of 41 ICs, not counting the power supply. Even then, it does not include a memory for the results of previous tries. However, it was felt that it would be cheaper to use a pencil and paper for that particular function . . . the mind-bender is only meant to replace the dummy player.

The large number of ICs suggests that it might be justified to use a micro-computer. This would solve the memory problem at the same time. Maybe it's an idea for some sophisticated TV games manufacturer in the not-too-distant future? **M**

# TBA 120T

Until the present time it has not been possible to build an FM receiver that requires absolutely no alignment. Despite the availability of pre-aligned front ends and the use of ceramic i.f. filters there has always been some adjustment to make. In i.f. strips with a quadrature demodulator for example, the quadrature coil must be adjusted. The introduction of ceramic phase shifters by Murata has eliminated even this adjustment. These elements were first developed for use in TV sound circuits where the elimination of production line adjustments saves a large amount of money. A 10.7 MHz version has now been introduced for use in FM radios and tuners, and Siemens have introduced a new version of the TBA 120 for use with these devices. This is designated the TBA 120T.

The circuit of a completely adjustment-free FM i.f. strip using the TBA 120T and Murata CDA 10.7MA is given in figure 1. This is used in the 'Local Radio' receiver described elsewhere in this issue. The i.f. output of the tuner feeds into a 10.7 MHz ceramic filter, which provides the i.f. selectivity. Transistor T1 provides some gain to compensate for the insertion loss of the filter and to boost the signal to a level suitable for feeding into the TBA 120T. L1, C2 and the internal input terminating resistance of the TBA 120T form an impedance matching network for 10.7 MHz, so this value of L1 must be adhered to. The phase shift network comprises the ceramic phase-shift element and capacitor C6.

The TBA 120T incorporates an electronic gain control so that no volume control is required in the succeeding a.f. amplifier. This makes the circuit eminently suitable for inexpensive (mono) f.m. receivers. The control is effected by P1 and has a range of about 60 dB.

A prototype i.f. strip was built using the TBA 120T and CDA 10.7MA in this circuit, and the following test results were obtained:

- ( $F_{in}$  = 10.7 MHz, deviation  $\pm$  40 kHz)
- sensitivity for 26 dB s/n: about 20  $\mu$ V
- output voltage for 3% distortion: 2V RMS
- current consumption at 12V supply: 35 mA
- volume control range: 60 dB

				Black	White
1	2	3	4		XX
5	6	7	8		X
9	0	1	2	XX	
9	3	1	4	X	X
5	6	1	3		
9	4	7	2	XX	XX
9	7	4	2	XXXX	!



# The easy way to a PCB...

...the Seno 33 system!

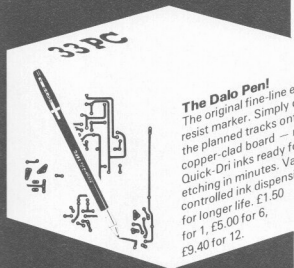

**The Dalo Pen!**  
The original fine-line etch resist marker. Simply draw the planned tracks onto the planned board — new copper-clad board — new Quick-Dri inks ready for etching in minutes. Valve controlled ink dispensing for longer life. £1.50 for 1, £5.00 for 6, £9.40 for 12.

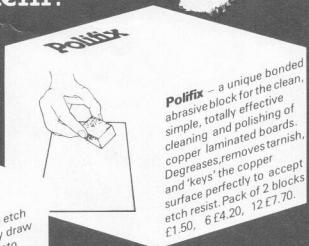

**Polifix** — a unique bonded abrasive block for the clean, simple, totally effective cleaning and polishing of copper laminated boards. Decreases, removes tarnish, and 'keys' the copper surface perfectly to accept etch resist. Pack of 2 blocks £1.50, 6 £4.20, 12 £7.70.

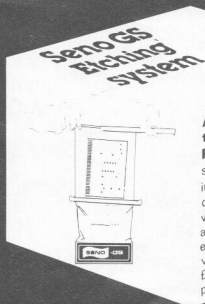

**A revolutionary solution to the problems of etching PCBs!** Unique sealed system minimises the risk, inconvenience, storage and disposal problems associated with the use of acid etchants — a complete kit designed to etch up to eight boards rapidly, visibly, effectively and SAFELY! £4.00 for a complete kit, £3.45 per kit in packs of 6.

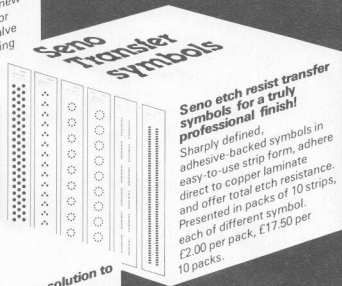

**Seno etch resist transfer symbols for a truly professional finish!**  
Sharply defined, adhesive-backed symbols in easy-to-use strip form, adhere direct to copper laminate and offer total etch resistance. Presented in packs of 10 strips, each of different symbol. £2.00 per pack, £17.50 per 10 packs.

## Seno 33 — The Laboratory in a box

From your usual component supplier or direct from:

DECON LABORATORIES LTD.  
Ellen Steet, Portslade,  
Brighton BN4 1EQ  
Telephone: (0273) 414 371  
Telex: IDACON BRIGHTON 87443

# The new Maplin Catalogue is no ordinary catalogue...

Hundreds of fascinating new lines

Several major new projects to build

**MAPLIN ELECTRONIC SUPPLIES**

**SUPERSONIC SAME DAY SERVICE!**  
**QUALITY COMPONENTS FAST!**

Discount Voucher saves you pounds!

Hundreds of photos and illustrations

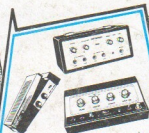

A range of ready-made musical effects units: Echo Chamber, Fuzz-Waa Pedal, Vibra-Chorus (tremolo, vibrato, phasing). Just compare our prices for these professional units.



Projects section includes full construction details of a guitarist's/organist's 13-note foot pedal. Features a very realistic bass guitar sound plus four organ stops on two footages. Self-contained, simply plugs into any amplifier.



Semiconductor section includes full details of a range of fascinating I.C.'s: T.V. games, Rhythm generator, Preset on and off timer/clock - plus radio IC's, op amps, voltage regulators, mono and stereo power amp IC's etc.

Catalogue includes a very wide range of components: hundreds of different capacitors; resistors; transistors; I.C.'s; diodes; wires and cables; discotheque equipment; organ components; musical effects units; microphones; turntables; cartridges; styli; test equipment; boxes and instrument cases; knobs, plugs and sockets; audio leads; switches; loudspeakers; books; tools - AND MANY MANY MORE.

SEND THIS COUPON FOR **YOUR** COPY OF OUR CATALOGUE ON APPROVAL! Price 50p - SEND NO MONEY NOW. Please rush me a copy of your brand new 1977/78 catalogue the instant it is published. Only if I am completely satisfied that it is worth every penny, will I send 50p within 14 days of receipt. If I am not satisfied, I may return the catalogue to you within 14 days without obligation. I understand that I need not purchase anything from your catalogue should I choose to keep it.

NAME \_\_\_\_\_

ADDRESS \_\_\_\_\_

Maplin Electronic Supplies P.O. Box 3, Rayleigh, Essex, SS6 6LR

Owing to delay in completion of larger warehouse, catalogue will be delayed by up to four weeks - so there's still time to order before publication and get your pack of ten super special offer coupons, giving big discounts on ten different popular items. **YOU COULD SAVE POUNDS! - SO DON'T DELAY - FILL IN AND POST COUPON NOW!**



\* Our bi-monthly newsletter keeps you up to date with latest guaranteed prices - our latest special offers (they save you pounds) - details of new projects and new lines. Send 30p for the next six issues (5p discount voucher with each copy).

**MAPLIN**  
ELECTRONIC SUPPLIES  
P.O. BOX 3, RAYLEIGH, ESSEX SS6 6LR  
Shop: 284, London Road, Westcliff-on-Sea, Essex  
(Closed on Monday) Telephone: Southend (0702) 44101